



**VEX** V5  
ROBOTICS  
**COMPETITION**  
**HIGH STAKES**

2024 - 2025  
Game Manual  
Version 1.1

# Table of Contents

## Prefix

Changelog .....	v
Quick Reference Guide .....	vii

## Section 1

Introduction .....	1
V5RC High Stakes: A Primer .....	2
About the Game Manual - A Note from the GDC .....	3
Updates .....	4
The Q&A System.....	5

## Section 2

The Game .....	6
Field Overview.....	6
General Definitions.....	8
Game-Specific Definitions .....	13
Scoring.....	17
Safety Rules .....	23
General Game Rules .....	24
Specific Game Rules.....	32

## Section 3

The Robot .....	41
Inspection Rules.....	41

## Section 4

The Tournament .....	55
Tournament Definitions .....	55
Tournament Rules.....	58

## Section 5 - Robot Skills

Robot Skills Challenge Description.....	69
Robot Skills Challenge Definitions .....	70
Robot Skills Challenge Rules .....	71
Robot Skills Challenge Scoring .....	73
Skills Stop Time .....	73
Robot Skills Challenge Ranking at Events .....	74
Robot Skills Challenge Ranking Globally .....	75
League Events .....	75

## Section 6 - VEX U Robotics Competition

Event Information .....	76
Game, Robot, and Tournament Rules.....	76
VURC Definitions.....	76
Rule Modifications: Field Setup .....	77
Rule Modifications: Game .....	79
Rule Modifications: Robot.....	80
Rule Modifications: Tournament .....	86
Rule Modifications: Robot Skills Challenge.....	87
Team Composition .....	88

## Section 7 - VEX AI Robotics Competition

Introduction.....	89
Game, Robot, and Tournament Rules .....	89
Rule Modifications: Field Setup .....	89
Game Definitions.....	90
Rule Modifications: Game.....	90
Rule Modifications: Tournament .....	91
Rule Modifications: Robot.....	92

## Appendix A - Field Overview

Game Field Introduction.....	A-1
Field Overview.....	A-2
Game Objects & Field Bill of Materials .....	A-3
Field Specifications Introduction.....	A-4

# fix

## Changelog

### Version 1.1 - August 6, 2024

- Added Grey Boxes throughout the manual to highlight significant Q&As pertaining to individual rules
- Rewrote the definition of *Plowing*
- Updated <SG2> with new verbiage and figures to clarify intent
- Updated <SG5c> to include *Scoring Objects*
- Updated <SG10> to clarify Scoring for *Rings* that end the *Match* on the opposing color *Alliance Wall Stake*
- Updated <SG11> to clarify intent
- Minor typo / formatting fixes

### Version 1.0 - June 25, 2024

- Changed the *Field* layout such that *Positive Corners* and *Negative Corners* are now on the same side of the *Field*, rather than catercornered
- Updated Figures throughout the manual to display the new *Corner* layout
- Added a new definition of "*Plane*"
- Expanded <SC3> to clarify that *Rings* can only be counted for points once, even in situations where they qualify as *Scored* on multiple *Stakes*
- Updated Figures SC7-1 and SG3-1 to show *Planes*
- Updated <SC7di> to clarify intent
- Revised <SC8> to clarify the *Autonomous Win Point* requirements
- Added a new rule, <SC9>, that adds a 2-point bonus per *Climb* for whichever *Alliance* has a *Ring Scored* on the *High Stake* at the end of a *Match*
- Updated <SG2> to clarify that *Robots* may expand beyond their starting size and configuration
- Added an additional bullet to <SG3> and updated the red box to clarify intent
- Added an additional Violation Note to <SG4> to state that a *Team* will receive a *Major Violation* for removing three (3) or more *Rings* from the *Field* in a single *Match*
- Rewrote <SG5c> to clarify that preloads cannot start in a *Scored* location or in contact with *Stakes*
- Updated <SG9> to clarify that *Teams* cannot negate an opponent's *Climb* by contacting their *Robot* with a *Mobile Goal*
- Added a new rule, <SG11>, to add a 10 second protection to *Positive Corners* at the end of a *Match*
- Updated <R10bi> to clarify intent regarding License Plates showing the wrong color
- Added two new bullets to <RSC3> to clarify that the blue *Alliance Stake* may be used in *Robot Skills Matches*, and that *Positive Corners* aren't protected at the end of a *Match*
- Updated <VUG1c> to reflect changes in <SG3>
- Added Section 7, VEX AI Robotics Competition
- Minor typo / formatting fixes

### Version 0.2 - June 4, 2024

- Updated Figure SC3-2 to show a different angle that more clearly shows the *Scored Rings*
- Updated <SC8> to clarify that at least one *Robot* must be touching the *Ladder*
- Added a bullet to <SG5> to clarify that preloads may not start in a *Scored* location
- Updated <SG6> to clarify *Possession* limits
- Deleted <SG6a>; <SG6a-i> was moved into the main part of the rule
- Updated the *Violation* Note of <SG6> to clarify that an intentional *Violation* will be considered a *Major Violation*, rather than *Match Affecting*
- Updated <R16e> to clarify that <R8d> is an exception
- Updated <T10d> and <T10e> to clarify *Ring* and *Mobile Goal* weights
- Updated <RSC4> to clarify intent, and added a new bullet point
- Minor typo / formatting fixes

### Version 0.1 - April 30, 2024

- Initial Release

# Quick Reference Guide

Scoring Rules	
<SC1>	All Scoring statuses are evaluated after the <i>Match</i> ends.
<SC2>	Scoring of the <i>Autonomous Bonus</i> is immediately after the <i>Autonomous Period</i> ends
<SC3>	<i>Scored on a Stake</i> criteria
<SC4>	<i>Top Ring</i> criteria
<SC5>	<i>Placed in a Corner</i> criteria
<SC6>	<i>Corner</i> modifiers to <i>Scored Rings</i>
<SC7>	<i>Climbed to a Level</i> criteria
<SC8>	<i>Autonomous Win Point</i>
<SC9>	<i>High Stake</i> bonus

Safety Rules	
<S1>	Be safe out there
<S2>	<i>Students</i> must be accompanied by an Adult
<S3>	Stay inside the <i>Field</i>
<S4>	Wear safety glasses

General Game Rules	
<G1>	Treat everyone with respect
<G2>	V5RC is a <i>Student</i> -centered program
<G3>	Use common sense
<G4>	The <i>Robot</i> must represent the skill level of the <i>Team</i>
<G5>	<i>Robots</i> begin the <i>Match</i> in the starting volume
<G6>	Keep your <i>Robots</i> together
<G7>	Don't clamp your <i>Robot</i> to the <i>Field</i>
<G8>	Only <i>Drive Team Members</i> , and only in the <i>Alliance Station</i>
<G9>	Hands out of the <i>Field</i>
<G10>	Controllers must stay connected to the <i>Field</i>
<G11>	Autonomous means "no humans"
<G12>	All rules still apply in the <i>Autonomous Period</i>
<G13>	Don't destroy other <i>Robots</i>
<G14>	Offensive <i>Robots</i> get the "benefit of the doubt"
<G15>	You can't force an opponent into a penalty
<G16>	No <i>Holding</i> for more than a 5-count
<G17>	Use <i>Scoring Objects</i> to play the game

### Specific Game Rules

<SG1>	Starting a <i>Match</i>
<SG2>	Horizontal expansion is limited
<SG3>	Vertical expansion is limited
<SG4>	Keep <i>Scoring Objects</i> in the field
<SG5>	Each <i>Robot</i> gets one <i>Ring</i> as a preload
<SG6>	<i>Possession</i> is limited to two <i>Rings</i> and/or one <i>Mobile Goal</i>
<SG7>	Don't cross the <i>Autonomous Line</i>
<SG8>	Engage with the <i>Autonomous Line</i> at your own risk
<SG9>	Don't remove opponents from the <i>Ladder</i>
<SG10>	<i>Alliance Wall Stakes</i> are protected
<SG11>	<i>Positive Corners</i> are "safe" during the endgame

### Robot Rules

<R1>	One <i>Robot</i> per <i>Team</i>
<R2>	<i>Robots</i> must represent the <i>Team's</i> skill level
<R3>	<i>Robots</i> must pass inspection
<R4>	<i>Robots</i> must fit within an 18" x 18" x 18" volume
<R5>	<i>Robots</i> may only expand horizontally in one direction
<R6>	<i>Robots</i> must be safe
<R7>	<i>Robots</i> are built from the VEX V5 system
<R8>	Certain non-VEX components are allowed
<R9>	Decorations are allowed
<R10>	Officially registered <i>Team</i> numbers must be displayed on <i>Robot</i> license plates
<R11>	Let go of <i>Scoring Objects</i> after the <i>Match</i>
<R12>	<i>Robots</i> have one Brain
<R13>	Motors are limited
<R14>	Electrical power comes from VEX batteries only
<R15>	No modifications to electronic or pneumatic components are allowed
<R16>	Most modifications to non-electrical components are allowed
<R17>	<i>Robots</i> use VEXnet
<R18>	Give the radio some space
<R19>	A limited amount of custom plastic is allowed
<R20>	A limited amount of tape is allowed
<R21>	Certain non-VEX fasteners are allowed
<R22>	New VEX parts are legal
<R23>	Pneumatics are limited
<R24>	One or two Controllers per <i>Robot</i>
<R25>	Custom V5 Smart Cables are allowed
<R26>	Keep the power button accessible
<R27>	Use a "Competition Template" for programming
<R28>	There is a difference between accidentally and willfully violating a <i>Robot</i> rule



### Tournament Rules

<T1>	<i>Head Referees</i> have final authority on all gameplay ruling decisions
<T2>	<i>Head Referees</i> must be qualified
<T3>	The Drive Team is permitted to immediately appeal a <i>Head Referee's</i> ruling
<T4>	<i>Event Partners</i> have final authority regarding all non-gameplay decisions
<T5>	A <i>Team's Robot</i> and/or <i>Drive Team Member</i> should attend every <i>Match</i>
<T6>	<i>Robots</i> at the field must be ready to play
<T7>	<i>Match replays</i> are allowed, but rare
<T8>	<i>Disqualifications</i>
<T9>	Each <i>Elimination Alliance</i> gets one <i>Time Out</i>
<T10>	Be prepared for minor <i>Field</i> variance
<T11>	<i>Fields</i> may be repaired at the <i>Event Partner's</i> discretion
<T12>	The red <i>Alliance</i> places last
<T13>	<i>Qualification Matches</i> follow the <i>Match Schedule</i>
<T14>	Each <i>Team</i> will have at least six <i>Qualification Matches</i>
<T15>	<i>Qualification Matches</i> contribute to a <i>Team's</i> ranking for <i>Alliance Selection</i>
<T16>	<i>Qualification Match</i> tiebreakers
<T17>	Send a <i>Student</i> representative to <i>Alliance Selection</i>
<T18>	Each <i>Team</i> may only be invited once to join one <i>Alliance</i>
<T19>	<i>Elimination Matches</i> follow the <i>Elimination Bracket</i>
<T20>	<i>Elimination Matches</i> are a blend of "Best of 1" and "Best of 3"
<T21>	Small tournaments may have fewer <i>Alliances</i>
<T22>	<i>Fields</i> at an event must be consistent with each other
<T23>	There are three types of field control that may be used
<T24>	There are two types of <i>Field Perimeter</i> that may be used

### Robot Skills Challenge Rules

<RSC1>	All rules from "The Game" section still apply, unless otherwise noted
<RSC2>	Skills Match Schedule
<RSC3>	<i>Robots</i> must start the <i>Robot Skills Match</i> in a legal starting position for the red <i>Alliance</i>
<RSC4>	Blue <i>Rings</i> may only be <i>Scored</i> as <i>Top Rings</i> on <i>Stakes</i> .
<RSC5>	Any red <i>Ring</i> <i>Scored</i> above a blue <i>Ring</i> on the same <i>Stake</i> will not have a point value
<RSC6>	<i>Top Ring</i> criteria
<RSC7>	No <i>Corner Modifiers</i>
<RSC8>	Skills Challenge <i>Fields</i> do not require the same modifications as the <i>Head-to-Head Fields</i>

### VURC Game Rules

<VUG1>	Different expansion
<VUG2>	Different <i>Climbing</i>
<VUG3>	Different autonomous

### VURC Robot Rules

<VUR1>	<i>Teams may use two (2) Robots in each Match</i>
<VUR2>	<i>Teams may use any official VEX Robotics products</i>
<VUR3>	<i>Fabricated Parts</i>
<VUR4>	<i>Fabricated Parts must be made from legal Raw Stock</i>
<VUR5>	<i>Raw Stock</i>
<VUR6>	<i>Fabricated Parts may not be made from Raw Stock which poses a safety or damage risk</i>
<VUR7>	<i>Fabricated Parts must be made by Team members</i>
<VUR8>	<i>Springs</i>
<VUR9>	<i>Fasteners</i>
<VUR10>	<i>One (1) V5 Robot Brain and up to two (2) V5 Robot Radios</i>
<VUR11>	<i>No motor restrictions</i>
<VUR12>	<i>No sensor and other Additional Electronics restrictions</i>
<VUR13>	<i>Unlimited amount of the following commercially available pneumatic components</i>
<VUR14>	<i>Teams may use commercially available bearings on their Robot</i>

### VURC Tournament Rules

<VUT1>	<i>VURC Matches will be played 1-Team vs. 1-Team</i>
<VUT2>	<i>Qualification Matches will be conducted in the 1v1 format</i>
<VUT3>	<i>Elimination Matches will be conducted without an Alliance Selection</i>
<VUT4>	<i>The Autonomous Period at the beginning of each Head-to-Head Match will be 30 seconds</i>
<VUT5>	<i>The Driver Controlled Period is shortened to 90 seconds</i>
<VUT6>	<i>Each Robot is allowed up to three (3) Drive Team Members in the Alliance Station</i>
<VUT7>	<i>VURC Student eligibility</i>

### VURC Robot Skills Rules

<VURS1>	<i>Different Field layout for VURC Robot Skills Matches</i>
<VURS2>	<i>Both Robots must start in legal starting positions for the red Alliance</i>
<VURS3>	<i>There are no preloads in VURC Robot Skills Matches</i>
<VURS4>	<i>Scored Blue Ring criteria</i>

**VEX AI Game Rules**

<b>&lt;VAIG1&gt;</b>	All <VUGx>, <SCx>, and <Sx> and rules apply as written
<b>&lt;VAIG2&gt;</b>	<i>Drive Team Members</i> are not permitted to interact with their <i>Robots</i> in any way
<b>&lt;VAIG3&gt;</b>	<i>Teams</i> are responsible for the actions of their <i>Robots</i> throughout the entirety of a <i>Match</i>
<b>&lt;VAIG4&gt;</b>	<i>Robots</i> may only <i>Climb</i> the <i>Ladder</i> on their <i>Alliance's</i> side of the <i>Autonomous Line</i>

**VEX AI Tournament Rules**

<b>&lt;VAIT1&gt;</b>	The following VURC rules apply as written
<b>&lt;VAIT2&gt;</b>	VAIRC <i>Teams</i> may consist of <i>Students</i> that fall into one of the following categories
<b>&lt;VAIT3&gt;</b>	<i>Students</i> may only participate on one (1) VAIRC <i>Team</i> in a given season

**VEX AI Robot Rules**

<b>&lt;VAIR1&gt;</b>	All <VURx> rules apply as written.
<b>&lt;VAIR2&gt;</b>	Any components used for AI vision processing, are considered <i>Additional Electronics</i>
<b>&lt;VAIR3&gt;</b>	<i>Crossover Teams</i> are encouraged to build separate <i>Robots</i> , but it is not required

# Section 1

## Introduction

### Overview

This section provides an introduction to the VEX V5 Robotics Competition (V5RC) and V5RC High Stakes.

### The VEX V5 Robotics Competition

Our world faces a serious problem. It's a problem that, without explicit and intentional action, will eventually stagnate global progress and lead to a workforce that is unmotivated and ill-equipped to solve its future problems. As the world grows more technologically complex, the challenges we face every day will continue to escalate along with it. A cell phone has more failure modes than a landline. The internals of an electric vehicle are more difficult to comprehend than a V8 combustion engine. Unmanned drone legislation is more nuanced than defining a maximum speed limit.

Dubbed "the STEM problem," the situation is equally simple to understand, yet difficult to solve. In many cases, the traditional methods of teaching science, technology, engineering, and math (STEM) will not be enough to adequately prepare students for this complex world. This is often coupled with the unfortunate reality that by the time they reach an age capable of grasping these critical topics, students may have already determined that they are "not cool" or "boring." Without the skills or passion necessary to approach these problems in an educated manner, you cannot possibly expect to be productive in making forward progress or even sustaining the status quo.

The VEX V5 Robotics Competition exists to solve this problem. Through its uniquely engaging combination of teamwork, problem solving, and scientific discovery, the study of competitive robotics encompasses aspects of STEM. You're not building VEX robots because your future job will involve tightening shaft collars on a metal bar—you're executing an engineering design and problem-solving process that resembles the same mindset used by rocket scientists, brain surgeons, and inventors around the world. VEX V5 Robotics Competition High Stakes is not just a game that we invented because it is fun to play—it is a vehicle for teaching (and testing) teamwork and perseverance in the face of hardship, and provides a methodology to approach and solve new challenges with confidence.

Contained in this manual are the rules that shape V5RC High Stakes. These rules are designed to simulate the constraints that will outline any real-world project. They are intended to promote creativity without punishing innovation. They are balanced to promote fair play while encouraging competition.

We encourage you to keep in mind that a VEX V5 Robotics Competition game is more than just a set of game objectives worth varying amounts of points. It is an opportunity to hone the lifelong skills that will characterize the problem-solving leaders of tomorrow.

Good luck, and we'll see you on the playing field!

Sincerely,

The VEX Robotics Game Design Committee, composed of members from the Robotics Education & Competition Foundation, DWAB Technology, and VEX Robotics

## V5RC High Stakes: A Primer

VEX V5 Robotics Competition High Stakes is played on a 12'x12' square *Field*, set up as illustrated in the figures throughout.

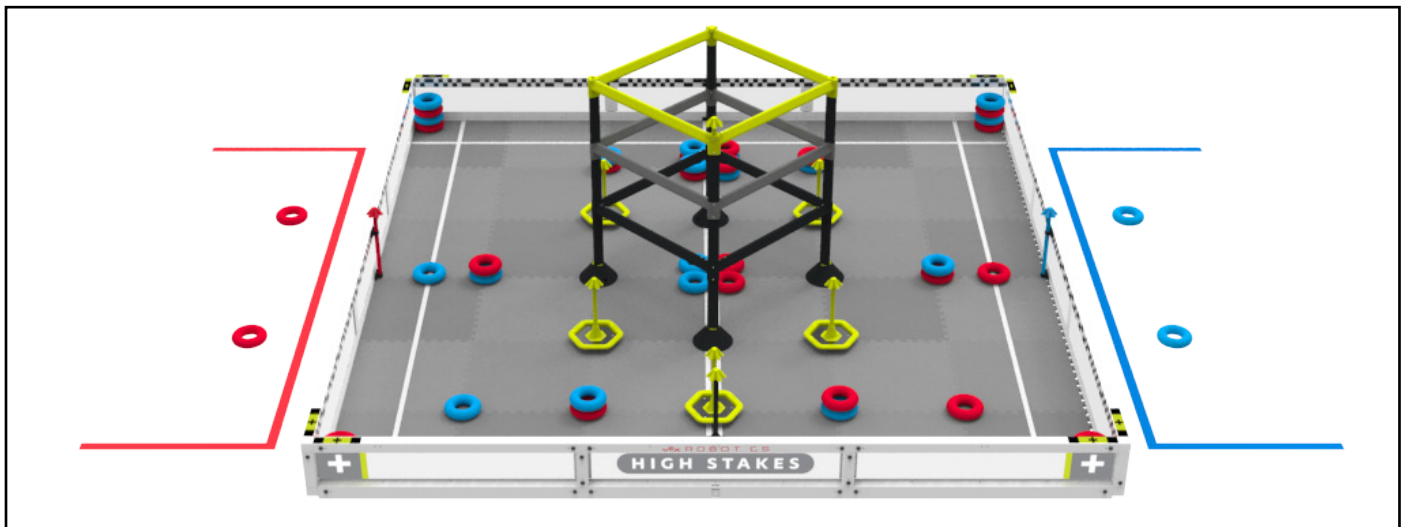
In Head-to-Head *Matches*, two (2) *Alliances*—one (1) "red" and one (1) "blue"—composed of two (2) *Teams* each, compete in *Matches* consisting of a fifteen (15) second *Autonomous Period* followed by a one minute and forty-five second (1:45) *Driver Controlled Period*.

The object of the game is to attain a higher score than the opposing *Alliance* by *Scoring Rings* on *Stakes*, *Placing Mobile Goals*, and *Climbing* at the end of the *Match*.

An *Autonomous Win Point* is awarded to any *Alliance* that completes four (4) assigned tasks by the end of the *Autonomous Period*.

An *Autonomous Bonus* is awarded to the *Alliance* that has the most points at the end of the *Autonomous Period*.

*Teams* may also compete in *Robot Skills Matches*, where one (1) *Robot* tries to score as many points as possible. See Section 5 for more information.



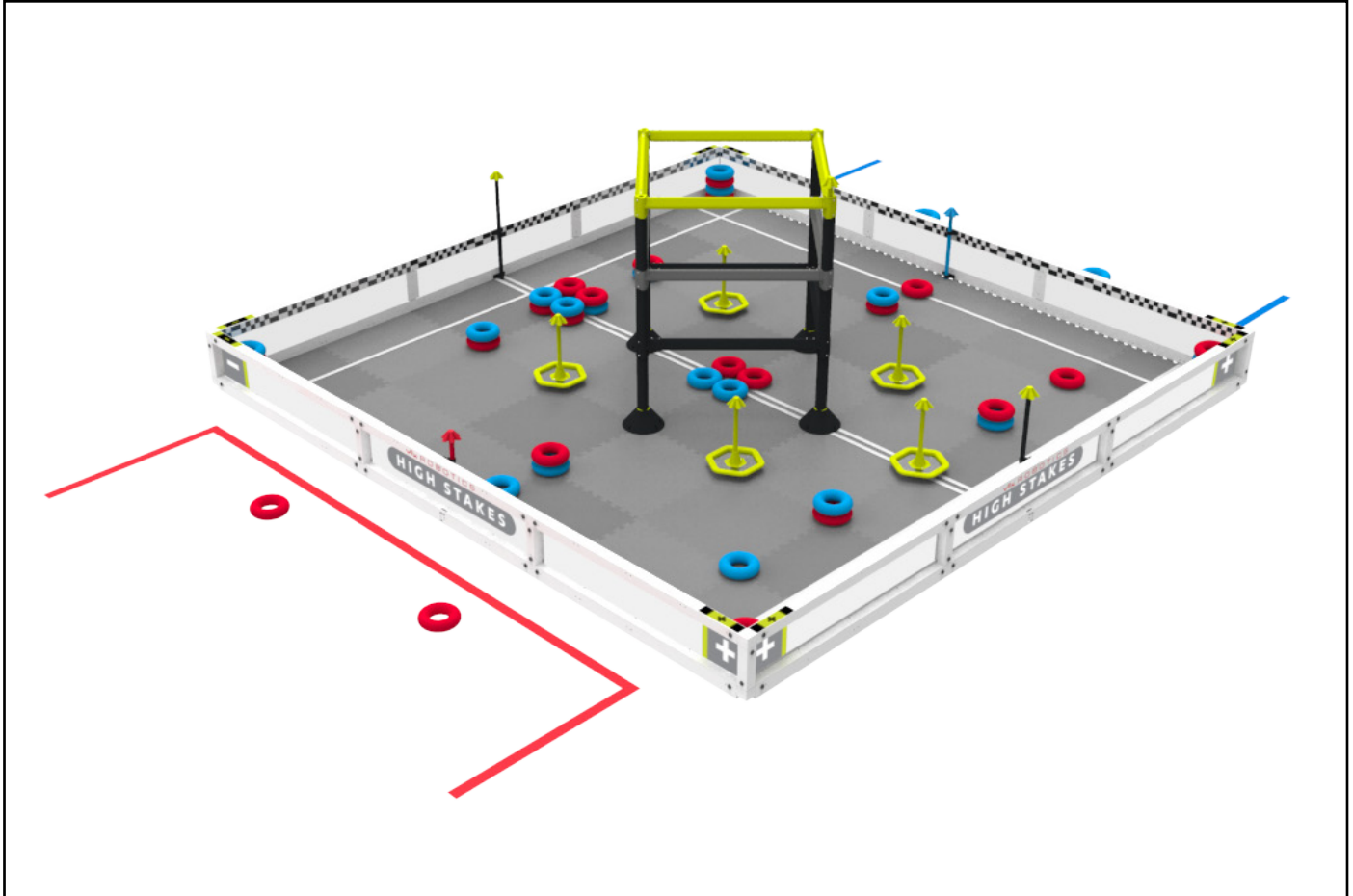
## About the Game Manual - A Note from the GDC

This Game Manual contains everything there is to know about this season's game, V5RC High Stakes. It is intended to be a resource for all *Teams*, *Head Referees*, *Event Partners*, and other members of the V5RC community.

The rules contained in the following pages can be thought of as "constraints" that define this game, just as engineers begin any design project by defining their constraints. At the beginning of a season, "constraints" are all we have. We don't know what the winning *Robot*, best strategy, or most-frequently-violated rule will be any more than you do. Isn't that exciting?

When exploring a new game, please approach this Game Manual with that mentality of looking at rules as "constraints." The Game Manual contains the full and complete list of constraints that are available for a competitor to strategize, design, and build their *Robots*.

Obviously, all *Teams* must adhere to these rules, and any stated intents of these rules. However, beyond that, there is no "right" way to play. There are no hidden restrictions, assumptions, or intended interpretations beyond what is written here. So, it is up to you, the competitor, to find the path through these constraints that best suits your team's goals and ambitions.



# Updates

This manual will have a series of “major” and “minor” updates over the course of the season. Each version is official and must be used in official V5RC events until the release of the next version, upon which the previous version becomes void.

The latest version of the Game Manual can always be found at:

<https://link.vex.com/docs/24-25/v5rc-high-stakes/GameManual>

Known major release dates are as follows:

<b>April 30, 2024</b>	<b>Version 0.1</b>	Initial game release
May 14, 2024	N/A	Official Q&A system opens
June 4, 2024	Version 0.2	Minor typographical errors or formatting issues found in the initial release. Very few rule changes are expected
<b>June 25, 2024</b>	<b>Version 1.0</b>	May include gameplay or rule changes inspired by input from the official Q&A system and the VEX community
August 6, 2024	Version 1.1	Clarification / minor update
<b>Sept. 3, 2024</b>	<b>Version 2.0</b>	May include gameplay or rule changes inspired by early-season events
Oct. 8, 2024	Version 2.1	Clarification / minor update
Dec. 3, 2024	Version 2.2	Clarification / minor update
<b>January 28, 2025</b>	<b>Version 3.0</b>	May include gameplay or rule changes inspired by mid-season events
<b>April 2, 2025</b>	<b>Version 4.0</b>	May include gameplay or rule changes pertaining specifically to the VEX Robotics World Championship

In addition to these known major updates, there may also be unscheduled updates released throughout the season if deemed critical by the GDC. **Any unscheduled updates will always be released on a Tuesday, no later than 5:00 PM CST (11:00 PM GMT).** These updates will be announced via the VEX Forum, automatically pushed to the V5RC Hub app, and shared via VEX Robotics / REC Foundation social media & email marketing channels.

Game Manual updates are effective immediately upon release; it is every *Team’s* responsibility to be familiar with all rules and updates. There are no “grace periods” if an update prohibits a previously legal part, mechanism, or strategy.

*Note: REC Foundation Regional Support Managers will contact Event Partners involved with multi-week league events that “cross over” an update, and/or Event Region Championships that occur within 2 weeks of an update. If a rule change impacts their event (such as a Robot which previously passed inspection no longer being legal), these cases will be reviewed individually depending on the context of the event and the rule that has changed. Exceptions may also be available for non-US championship events that occur within one (1) week of an update. These are the only possible “grace period” exceptions.*

# The Q&A System

When first reviewing a new robotics game, it is natural to have questions about situations which may not be immediately clear. Navigating the Game Manual and seeking out answers to these questions is an important part of learning a new game. In many cases, the answer may just be in a different place than you first thought—or, if there is no rule explicitly prohibiting a gameplay strategy, then that usually means it is legal!

However, if a *Team* is still unable to find an answer to their question after closely reviewing the relevant rules, then every *Team* has the opportunity to ask for official rules interpretations and clarifications in the VEX Robotics Question & Answer System. These questions may be posted by an *Adult* via the RobotEvents account that is associated with that *Team*.

All responses in this Q&A system should be treated as official rulings from the VEX Robotics *Game Design Committee*, and they represent the correct and official interpretation of the VEX V5 Robotics Competition Rules. The Q&A system is the only source besides the Game Manual for official rulings and clarifications, and is functionally an extension of the Game Manual. Like Game Manual updates, Q&A rulings are effective immediately upon release.

[The VEX V5 Robotics Competition Question & Answer System can be found here.](#)

Before posting on the Q&A system, be sure to review the [Q&A Usage Guidelines](#).

1. Read and search the manual before posting.
2. Read and search existing Q&As before posting.
3. Quote the applicable rule from the latest version of the manual in your question.
4. Make a separate post for each question.
5. Use specific and appropriate question titles.
6. Questions will (mostly) be answered in the order they were received.
7. This system is the only source for official rules clarifications.

If there are any conflicts between the Game Manual and other supplemental materials (e.g., Referee Certification courses, the V5RC Hub app, etc.), the most current version of the Game Manual takes precedence.

Similarly, it can never be assumed that definitions, rules, or other materials from previous seasons apply to the current game. Q&A responses from previous seasons are not considered official rulings for the current game. Any relevant clarifications that are needed should always be re-asked in the current season's Q&A.



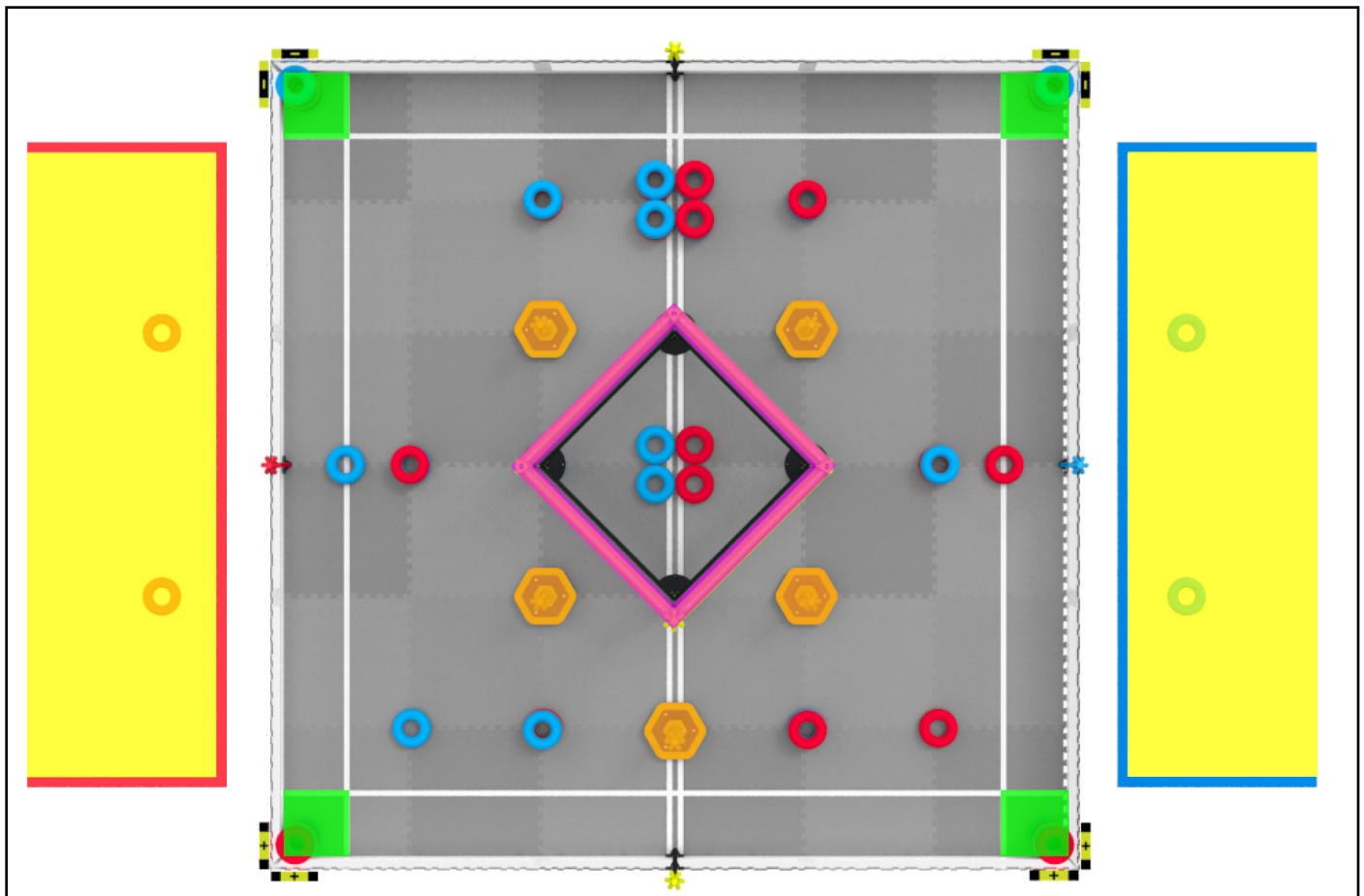
# Section 2

## The Game

### Field Overview

The VEX V5 Robotics Competition High Stakes field consists of the following:

- Five (5) *Mobile Goals*, each with one (1) *Stake*
- Four (4) *Wall Stakes*, one (1) per *Alliance* and two (2) neutral
- One (1) *Ladder*, with three (3) *Levels* and one (1) *High Stake*
- Forty-eight (48) *Rings*, twenty-four (24) of each color
- Four (4) *Corners*, two (2) *Positive* and two (2) *Negative*



**Figure FO-1:** Top view of the Field in its starting configuration, with highlighted Mobile Goals (orange), Alliance Stations (yellow), Corners (Green), and the Ladder (pink).

*Note: The illustrations in this section of the Game Manual are intended to provide a general visual understanding of the game. Teams should refer to official field specifications, found in Appendix A, for exact field dimensions, a full field bill of materials, and exact details of field construction.*

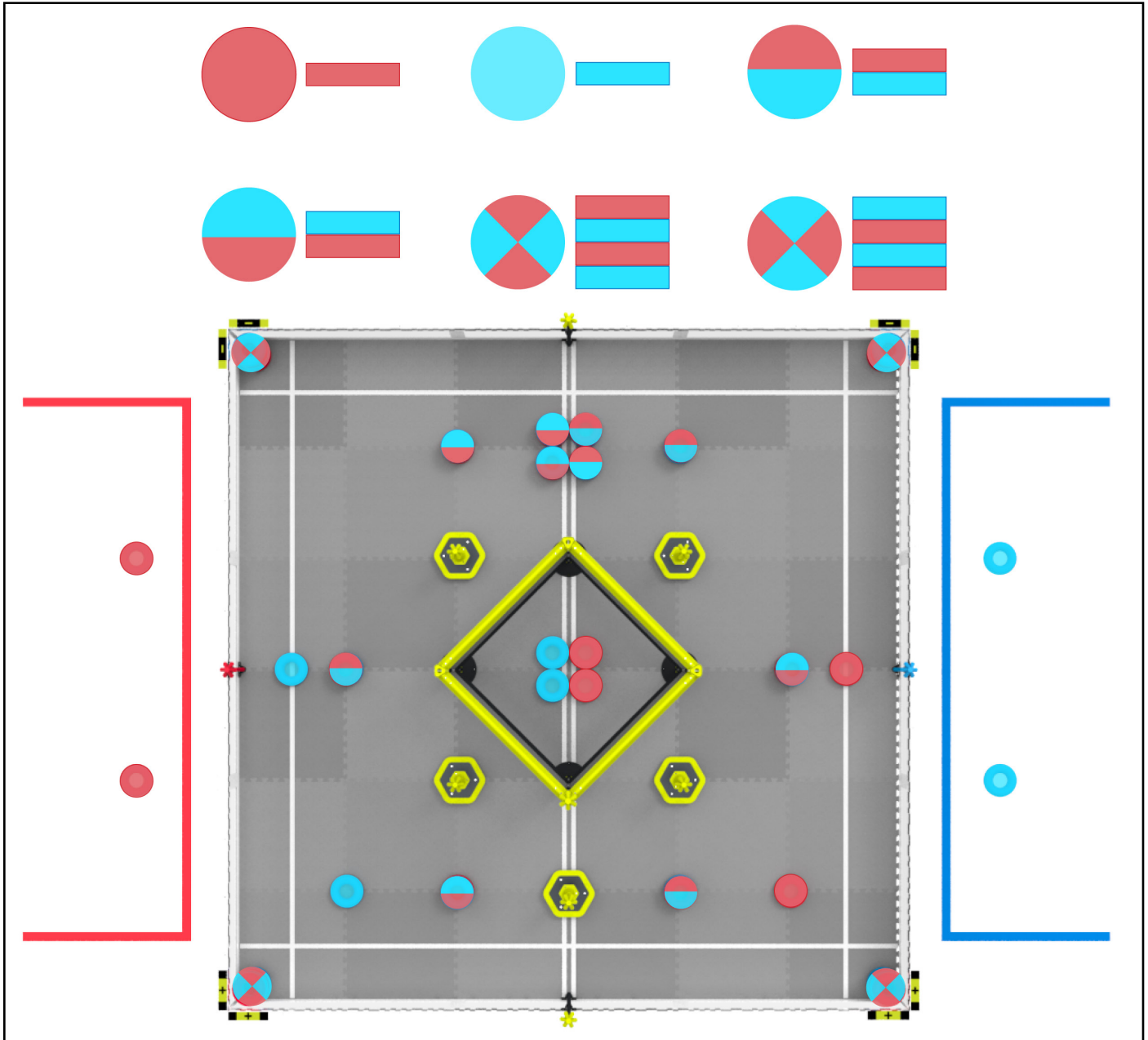


Figure FO-2: Top view of the Field in its starting configuration, with highlighted Rings (Red / Blue).

# General Definitions

**Adult** – Anyone who is not a *Student* or another defined term (e.g., *Head Referee*).

**Alliance** – A pre-assigned grouping of two (2) *Teams* that are paired together during a given *Match*.

**Alliance Station** – The designated regions where the *Drive Team Members* must remain for the duration of the *Match*.

**Autonomous Bonus** – A point bonus awarded to the *Alliance* that has earned the most points at the end of the *Autonomous Period*. See <SC2> for more information.

**Autonomous Win Point** – An additional *Win Point* awarded to any *Alliance* that has completed a defined set of tasks at the end of the *Autonomous Period* of a *Qualification Match*. See <SC8> for more information.

**Disablement** – A penalty applied to a *Team* for a safety *Violation*. A *Team* that receives a *Disablement* is not allowed to operate their *Robot* for the remainder of the *Match*, and the *Drive Team Member(s)* will be asked to place their controller(s) on the ground.

**Disqualification** – A penalty applied to a *Team* for a *Major Violation*. A *Team* that receives a *Disqualification* in a *Qualification Match* receives zero (0) *Win Points*, (0) *Autonomous Win Points*, (0) *Autonomous Points*, and (0) *Strength of Schedule Points*. When a *Team* receives a *Disqualification* in an *Elimination Match*, the entire *Alliance* is *Disqualified* and they receive a loss for the *Match*. At a *Head Referee's* discretion, repeated *Violations* and/or *Disqualifications* for a single *Team* may lead to its *Disqualification* for the entire tournament (see <T8>). A *Team* that receives a *Disqualification* in a *Driving Skills Match* or *Autonomous Coding Skills Match* receives a score of zero (0) for that *Robot Skills Match*.

**Drive Team Member(s)** – A *Student* who stands in the *Alliance Station* during a *Match*. *Adults* are not allowed to be *Drive Team Members*. See rules <G8>, <G9>, and <G10>.

**Entanglement** – A *Robot* status. A *Robot* is *Entangled* if it has grabbed, hooked, or attached to an opposing *Robot* or a *Field Element*. See rule <G13>.

**Field** – The entire playing *Field*, comprising the *Floor* and the *Field Perimeter*.

**Field Element** – The *Field*, white tape, *Ladder*, *Wall Stakes*, and all supporting structures or accessories (such as *Alliance Station* posts, field monitors, etc.).

**Field Perimeter** – The outer part of the *Field*, made up of twelve (12) straight sections.

**Floor** – The interior flat part of the playing *Field*, made up of six (6) grey foam field tiles wide by six (6) grey foam field tiles long (totaling thirty-six (36) field tiles) that are within the *Field Perimeter*.

**Game Design Committee (GDC)** – The creators of V5RC High Stakes, and authors of this Game Manual. The GDC is the only official source for rules clarifications and Q&A responses; see Section 1.

**Holding** – A *Robot* status; see rule <G16> for more information. A *Robot* is considered to be *Holding* if it meets any of the following criteria during a *Match*:

- **Trapping** – Limiting the movement of an opponent *Robot* to a small or confined area of the *Field*, approximately the size of one foam field tile or less, without an avenue for escape. Note that if a *Robot* is not attempting to escape, it is not considered *Trapped*.
- **Pinning** – Preventing the movement of an opponent *Robot* through contact with the *Field Perimeter*, a *Field* or Game Element, or another *Robot*.
- **Lifting** – Controlling an opponent's movements by raising or tilting the opponent's *Robot* off of the foam tiles.

If the *Head Referee* determines that the opponent *Robot* is not attempting to move or escape, then it is not considered *Pinned* or *Trapped*. This commonly occurs when the *Robot* has malfunctioned and lost the ability to move.

This criteria is not required for *Lifting*; the *Holding* status begins as soon as the opponent becomes *Lifted*.

**Match** – A set time period, consisting of *Autonomous* and/or *Driver Controlled Periods*, during which *Teams* play a defined version of High Stakes to earn points. See Section 4.

- **Autonomous Period** – A time period during which *Robots* operate and react only to sensor inputs and pre-programmed commands.
- **Driver Controlled Period** – A time period during which *Drive Team Members* operate their *Robot* via remote control.

Match Type	Participants	Pertinent Rules	Autonomous Period (m:ss)	Driver Controlled Period (m:ss)
Head-to-Head	Two <i>Alliances</i> (red/blue), each composed of two <i>Teams</i> , with one <i>Robot</i> each	Scoring ("SC"), Game ("G"), and Specific Game ("SG") sections	0:15	1:45
<i>Driving Skills Match</i>	One <i>Team</i> , with one <i>Robot</i>	Section 5	None	1:00
<i>Autonomous Coding Skills Match</i>	One <i>Team</i> , with one <i>Robot</i>	Section 5	1:00	None
VURC	Two <i>Teams</i> (red/blue), with two <i>Robots</i> each	Section 6	0:30	1:30
VEX AI	Two <i>Teams</i> , (red/blue), with two <i>Robots</i> each, utilizing the VEX GPS and VEX AI Camera	Section 7*	0:15	1:45

\*Note: The time periods in VAIRC are referred to as the Isolation Period and the Interaction Period.

**Robot** – A machine that has passed inspection, designed by *Student Team* Members to execute one or more tasks autonomously and/or by remote control from a *Drive Team Member*.

**Student** – A person is considered a *Student* if they meet both of the following criteria:

- Anyone who is earning or has earned credit toward a secondary school (i.e., high school) diploma, certificate, or other equivalent during the six (6) months preceding the VEX Robotics World Championship. Courses earning credits leading up to high school would satisfy this requirement.
- Anyone born after May 1, 2005 (i.e., who will be 19 or younger at VEX Worlds 2025). Eligibility may also be granted based on a disability that has delayed education by at least one year.
  - Middle School Student** – A *Student* born after May 1, 2009 (i.e., who will be 15 or younger at VEX Worlds 2025). Any *Students* who meet this criteria may also compete as *High School Students*.
  - High School Student** – Any eligible *Student* that is not a *Middle School Student*.

**Team** – One or more *Students* make up a *Team*.

- A *Team* is classified as a *Middle School Team* if all members are *Middle School Students*.
- A *Team* is classified as a *High School Team* if any of its members are *High School Students*, or if the *Team* is made up of *Middle School Students* who declare themselves "playing up" as *High School Students* by registering their *Team* as a *High School Team*.

- Once a *Team* has competed in an event as a High School *Team*, that *Team* may not change back to a Middle School *Team* for the remainder of the season.
- *Teams* may be associated with schools, community/youth organizations, or groups of neighborhood *Students*.

In the context of this Game Manual, *Teams* contain three types of *Student* roles related to *Robot* build, design, and coding. See <G2> and <G4> for more information. *Adults* may not fulfill any of these roles.

- **Builder** – The *Student(s)* on the *Team* who assemble(s) the *Robot*. *Adults* are permitted to teach the *Builder(s)* how to use concepts or tools associated with *Robot* construction, but may never work on the *Robot* without the *Builder(s)* present and actively participating.
- **Coder** – The *Student(s)* on the *Team* who write(s) the computer code that is downloaded onto the *Robot*. *Adults* are permitted to teach the *Coder(s)* how to use concepts or tools associated with programming, but may never work on the code that goes on the *Robot* without the *Coder(s)* present and actively participating.
- **Designer** – The *Student(s)* on the *Team* who design(s) the *Robot*. *Adults* are permitted to teach the *Designer(s)* how to use concepts or tools associated with design, but may never work on the design of the *Robot* without the *Designer(s)* present and actively participating.

**Violation** – The act of breaking a rule in the Game Manual.

- **Minor Violation** – A *Violation* which does not result in a *Disqualification*.
  - Accidental, momentary, or otherwise non *Match Affecting Violations* are usually *Minor Violations*.
  - *Minor Violations* usually result in a verbal warning from the *Head Referee* during the *Match*, which should serve to inform the *Team* that a rule is being *Violated* before it escalates to a *Major Violation*.
- **Major Violation** – A *Violation* which results in a *Disqualification*.
  - Unless otherwise noted in a rule, all *Match Affecting Violations* are *Major Violations*.
  - If noted in the rule, egregious or intentional *Violations* may also be *Major Violations*.
  - Multiple *Minor Violations* within a *Match* or tournament may escalate to a *Major Violation* at the *Head Referee's* discretion.
- **Match Affecting** – A *Violation* which changes the winning and losing *Alliance* in the *Match*.
  - Multiple *Violations* within a *Match* can cumulatively become *Match Affecting*.
  - When evaluating if a *Violation* was *Match Affecting*, *Head Referees* will focus primarily on any *Robot* actions that were directly related to the *Violation*.
  - Determining whether a *Violation* was *Match Affecting* can only be done once the *Match* is complete and the scores have been calculated.

Some rules include *Violation Notes* in *red italicized text* to denote special circumstances or provide additional clarifications. If no *Violation Notes* are found in a given rule, then it should be assumed that the above “default” definitions apply.

To determine whether a *Violation* may have been *Match Affecting*, check whether the *Team* who committed the *Violation* won or lost the *Match*. If they did not win the *Match*, then the *Violation* could not have been *Match Affecting*, and it was very likely a *Minor Violation*.

See the flowchart below for more information.

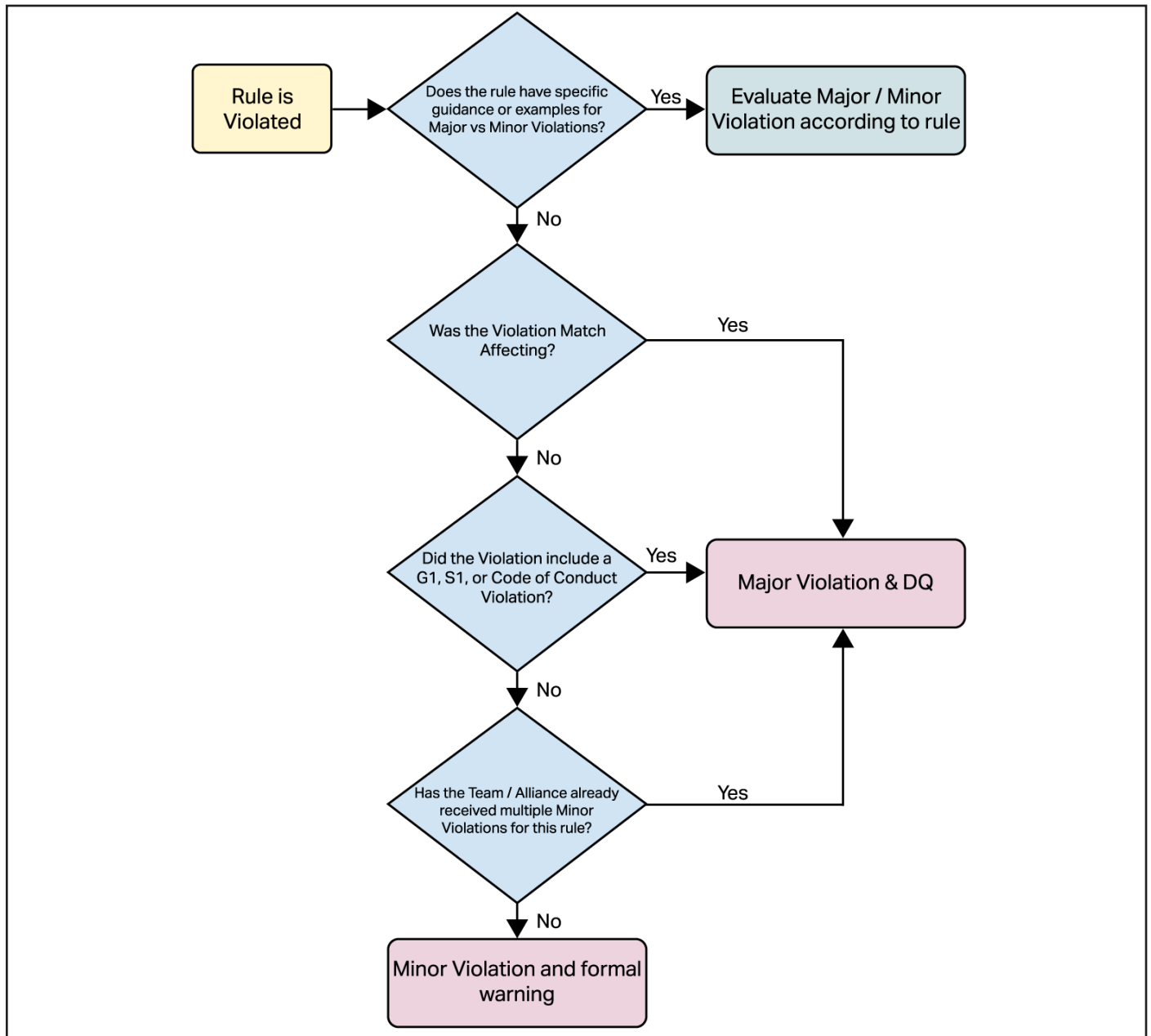


Figure V-1: The process for determining whether or not an infraction should result in a Major Violation or Minor Violation.

# Game-Specific Definitions

**Autonomous Line** – The pair of white tape lines that run across the field, and the space between those lines. See <SG7> for more information.

**Corner** – One of four 12" (304.8 mm) x 12" (304.8 mm) locations in which *Mobile Goals* can be *Placed*. The *Corners* are bounded by the inner edges of the *Field Perimeter* and the outer edge of the associated white tape lines. The *Corner* is defined as the foam tile and tape line themselves; it is not a 3-dimensional volume.

- **Negative Corner** - A *Corner* of the field, designated by the "-" sign on the stickers applied to the top of the *Field Perimeter*. See <SC5> and <SC6>.
- **Positive Corner** - A *Corner* of the field, designated by the "+" sign on the stickers applied to the top of the *Field Perimeter*. See <SC5> and <SC6>.

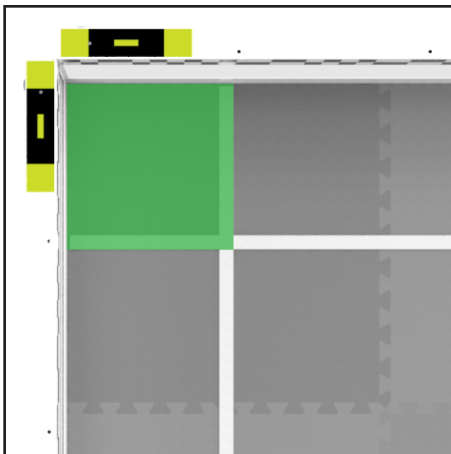


Figure C-1: A depiction of the Corner's boundaries.

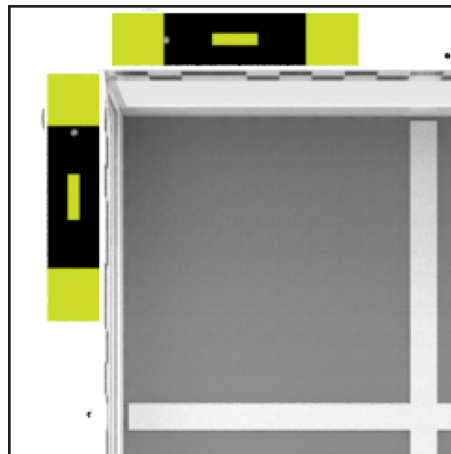


Figure C-2: A Negative Corner.

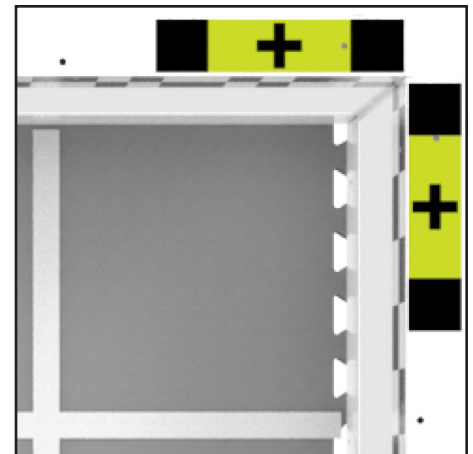


Figure C-3: A Positive Corner.

**Climb** – A *Robot* action. See <SC7>.

**Ladder** – A 36" (914.4 mm) x 36" (914.4 mm) x 46" (1168.4 mm) structure located in the center of the field. The *Ladder* has four vertical posts, and three sets of horizontal rungs at 18" (457.2 mm), 32" (812.8 mm), and 46" (1168.4 mm) to denote the three *Climbing Levels*. There is also a single *High Stake* atop the vertical post nearest the audience side of the *Field*, at the 180 degree mark on a GPS strip. All supporting structures, hardware, and the *High Stake* are considered part of the *Ladder*.





Figure L-1: The Ladder.

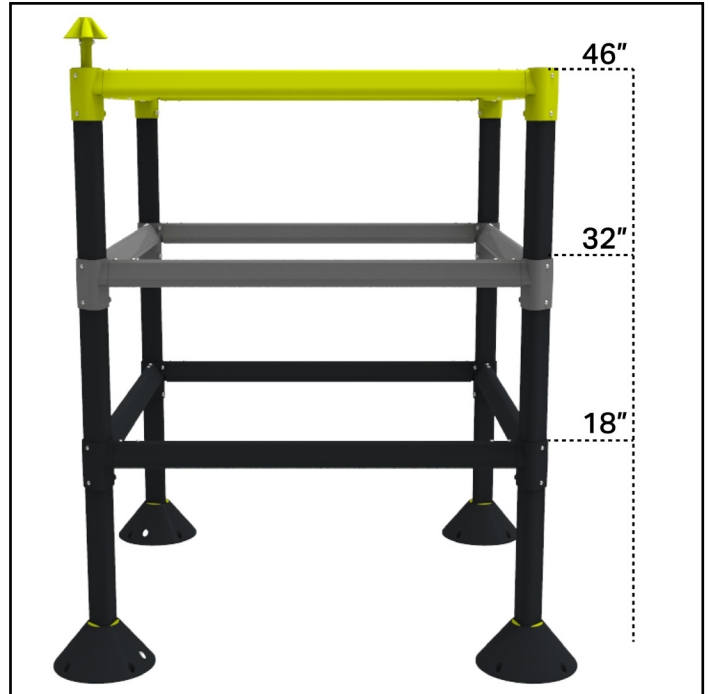


Figure L-2: A depiction of the heights for each Level of the Ladder.

**Level** – A status used for scoring and expansion rules. See <SC7> and <SG3>.

**Mobile Goal** – One of five (5) large *Scoring Objects*, each with a *Stake* in the center. *Mobile Goals* are hexagonal, with a maximal diameter of 10" (254 mm) and an overall height of 14.5" (368.3 mm). The *Stake* is considered part of the *Mobile Goal*.

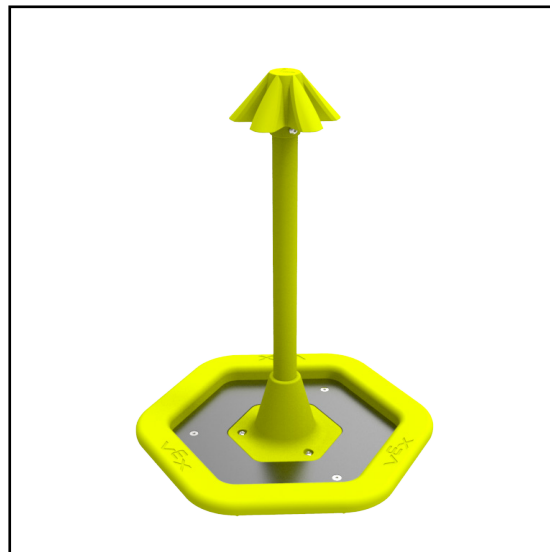


Figure MG-1: A depiction of a Mobile Goal.

**Placed** – A *Mobile Goal* status. See <SC5>.

**Plane** – An imaginary horizontal surface that divides the vertical space between two *Levels*, and expands infinitely across the *Field*.

**Plowing** – A *Robot / Scoring Object* status. A *Robot* is considered to be *Plowing* a *Scoring Object* if the *Robot* is intentionally moving it in a preferred direction with a flat or convex face of the *Robot* or with another *Scoring Object*.

**Possession** – A *Robot / Scoring Object* status. A *Scoring Object* is considered *Possessed* by a *Robot* if a *Robot's* change in direction would result in controlled movement of the *Scoring Object*. This typically requires at least one of the following to be true:

- The *Scoring Object* is fully supported by the *Robot*.
- The *Robot* is moving the *Scoring Object* in a preferred direction with a concave face of the *Robot* (or inside of a concave angle formed by multiple mechanisms/faces of the *Robot*).
- The *Robot* is holding the *Scoring Object* against the *Floor* or a *Field Element*.

The difference between *Possession* and *Plowing* is analogous to the difference between the terms "controlling" and "moving."

**Ring** – A hollow red or blue torus-shaped plastic object with an outer diameter of 7" (177.8 mm), an inner "hole" diameter of 3" (76.2 mm), and a thickness (or "tube diameter") of 2" (50.8 mm).

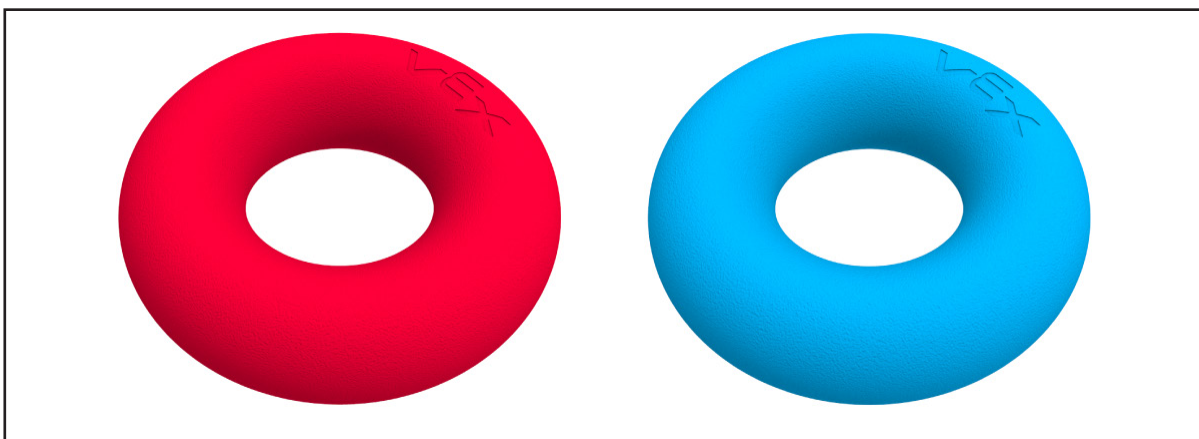



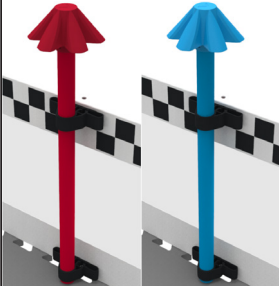
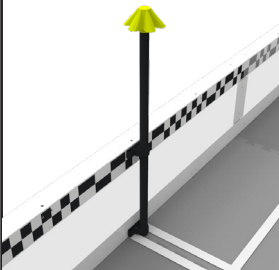
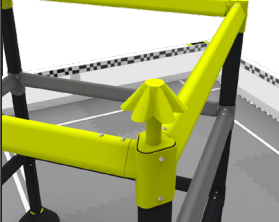
Figure R-1: A depiction of red and blue Rings.

**Scored** – A *Ring* status. See <SC3>.

**Scoring Object** – A *Ring* or *Mobile Goal*.

**Stake** – A vertical ½" (12.7 mm) Schedule 40 PVC pipe (gray, red, or blue) with a compliant barb at the top, used for Scoring *Rings*. There are ten (10) *Stakes*:

- Five (5) neutral *Stakes* in *Mobile Goals*, which fit six (6) *Rings* each
- Two (2) *Alliance Wall Stakes*, one per *Alliance*, which fit two (2) *Rings* each
- Two (2) neutral *Wall Stakes*, which fit six (6) *Rings* each
- One (1) neutral *High Stake*, which fits one (1) *Ring*

Stake	Image	Color	Location	Max # of Rings
Neutral <i>Mobile Goal Stake</i>		Yellow	<i>Mobile Goals</i>	6
<i>Alliance Wall Stake</i>		Red / Blue	<i>Field walls parallel to Alliance Stations</i>	2
Neutral <i>Wall Stake</i>		Grey / Yellow	<i>Field walls perpendicular to Alliance Stations</i>	6
<i>High Stake</i>		Yellow	Top of <i>Ladder</i>	1

**Starting Line** – An infinite vertical plane aligned with the outside edge (closest to the *Ladder*) of the white tape line that runs parallel to each *Alliance Station*. See <SG1>.

**Top Ring** – A *Ring* status. See <SC4>.

# Scoring

<i>Autonomous Bonus</i>	6 Points
Each <i>Ring Scored on a Stake</i>	1 Point
Each <i>Top Ring on a Stake</i>	3 Points
<i>Ring Scored on High Stake</i>	See <SC9>
<i>Climb - Level 1</i>	3 Points
<i>Climb - Level 2</i>	6 Points
<i>Climb - Level 3</i>	12 Points
Each <i>Ring Scored on a Mobile Goal Stake that has been Placed in a Corner</i>	See <SC6>

<SC1> All Scoring statuses are evaluated **after the Match ends**. Scores are calculated 5 seconds after the *Match* ends, or once all *Scoring Objects*, *Field Elements*, and *Robots* on the *Field* come to rest, whichever comes first.

- a. This 5 second delay is intended to be the only permitted “benefit of the doubt” for last-second scoring actions. If an object or *Robot* is still in motion and “too close to call” between two states at the 5-second mark, then the less advantageous of the two states should be awarded to the *Robot(s)* in question. For example:
  - i. A *Robot* which has *Climbed* on the *Ladder* but is slowly drooping down, and crosses a *Level* threshold right at 5 seconds, would be considered in the lower of the two *Levels*.
  - ii. A *Ring* which slowly slides out of a *Robot*’s mechanism and lands on a *Stake* right at 5 seconds would not be considered *Scored*.
- b. At the end of the *Match*, the on-screen timer displayed by Tournament Manager will hold the current *Match* information and “0:00” for 5 seconds before moving to queue the next *Match*. This should be the primary 5-second visual cue used by *Teams* and *Head Referees*.
- c. This 5 second delay is only intended to be a “benefit of the doubt” grace period, not an extra 5 seconds of *Match* time. *Robots* which are designed to strategically exploit this grace period will receive a *Minor Violation*, and any post-*Match* movement will not be included in score calculation (i.e., the *Match* will be scored as it was at 0:00).

<SC2> Scoring of the **Autonomous Bonus** is evaluated immediately after the *Autonomous Period* ends (i.e., once all *Scoring Objects*, *Field Elements*, and *Robots* on the *Field* come to rest).

- a. *Climb* points and *Corner* modifiers are not included in the calculation of an *Alliance*’s score for the purposes of determining the *Autonomous Bonus*.
- b. If the *Autonomous Period* ends in a tie, including a zero-to-zero tie, each *Alliance* will receive an *Autonomous Bonus* of three (3) points.
- c. Any rule *Violations*, Major or Minor, during the *Autonomous Period* will result in the *Autonomous Bonus* being awarded to the other *Alliance*. If both *Alliances* violate rules during the *Autonomous Period*, no *Autonomous Bonus* will be awarded.

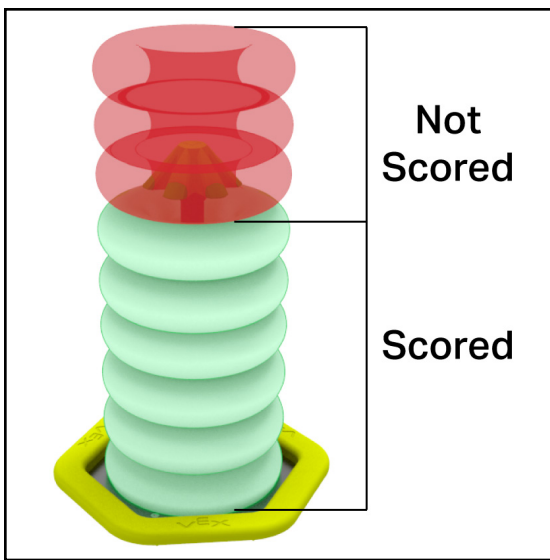
<SC3> A Ring is considered **Scored on a Stake** if it meets the following criteria:

- The Ring is not contacting a Robot from the same color Alliance as the Ring.
- The Ring is not contacting a gray foam tile.
- The Ring is "encircling" a Stake. In this context, "encircling" means that any part of the Stake is at least partially within the volume defined by the inner edges of the Ring. Each Ring can only be counted for points once, even in cases where the Ring qualifies as Scored on multiple Stakes. If multiple Stakes are encircled by the same Ring, Top Rings will not be awarded for those Stakes. Intentionally causing a Ring to be Scored on multiple Stakes will, at minimum, receive a Minor Violation.
- The Stake does not exceed its total permitted number of Rings (see definition of Stake). In the event of too many Rings on a Stake, the "highest" Rings will be removed.

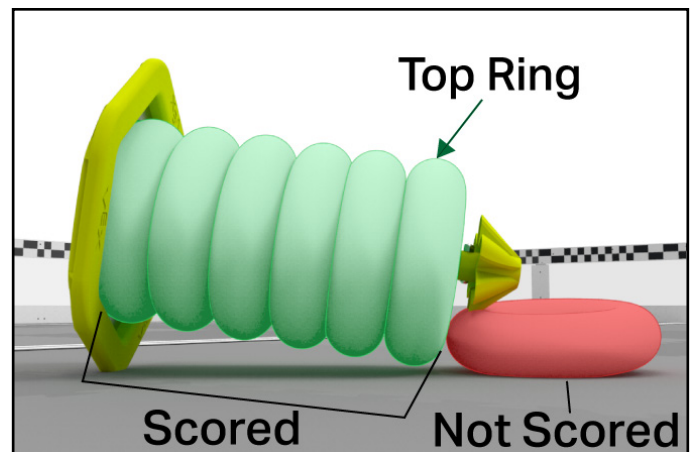
*Note: There is no requirement for a Mobile Goal to be upright in order for its Rings to be considered Scored. Contact with any other Field Elements or Rings, other than the criteria described above, is irrelevant.*

In the vast majority of common scenarios, a Scored Ring will be fully supported by the Stake, other Scored Rings, and/or the Stake's associated base (i.e., Mobile Goal, field wall, or Ladder). Although this support can be used as a visualization tool when judging edge-case Rings, it is **not explicitly required**.

Another visualization tool is that if a gentle "shake test" would result in the Ring falling anywhere other than further onto its Stake, then it is most likely not Scored (this test does not apply to tipped Mobile Goals).



**Figure SC3-1:** The six (6) green highlighted Rings would be considered as Scored, because they are "encircling" a Stake. The three (3) red highlighted Rings would not be considered as Scored, because they exceed the permitted number of Rings on the Mobile Goal Stake.



**Figure SC3-2:** Even though the Mobile Goal is not upright, the six (6) green highlighted Rings would be considered as Scored, because they meet all the other criteria listed above. The red highlighted Ring would not be considered as "Scored" because it is not "encircling" the Stake, and is touching the grey foam Field tile.

<SC4> A *Ring* is considered a **Top Ring** if it meets the following criteria:

- a. The *Ring* is *Scored* on a *Stake* (i.e., meets all criteria in <SC3>).
- b. The *Ring* is the furthest *Scored Ring* from a given *Stake's* base (i.e., *Mobile Goal* base or *Field Perimeter* wall).
- c. There is no minimum number of *Rings* required; if only one *Ring* is *Scored* on a *Stake*, then it is still considered that *Stake's Top Ring*.

*Note: A Ring that is considered a Top Ring does not also receive points for being Scored on a Stake; i.e., that Ring is worth 3 points, not a total of "3 + 1" points.*

*Note 2: If a Top Ring cannot be determined, but the two Rings in question are of the same color, then either of them may be considered the Top Ring. If the two Rings in question are of opposite colors, then that Stake will have no Top Rings.*

<SC5> A *Mobile Goal* is considered **Placed in a Corner** if it meets the following criteria:

- a. The *Mobile Goal's* base is contacting the *Corner* (i.e., the *Floor* and/or white tape line).
- b. It is "upright." For the purposes of this definition, a *Mobile Goal* is considered "upright" if no contact is being made between its *Stake* (and/or any *Rings* on this *Stake*) and the *Floor* or *Field Perimeter*.
- c. Contact with a *Robot* is irrelevant, as long as all other criteria are met.

*Note: Only one Mobile Goal may be considered Placed in each Corner. If two Mobile Goals meet the above requirements in the same Corner, the following criteria will be used as a series of "tiebreakers" to determine which Mobile Goal is Placed:*

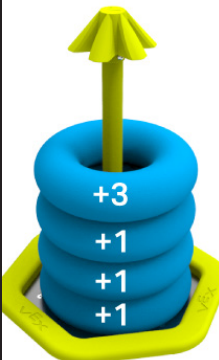
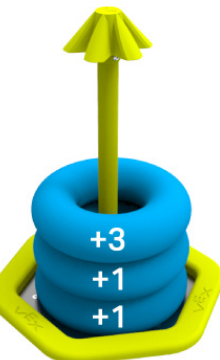
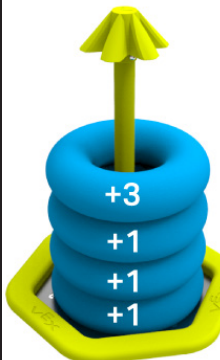
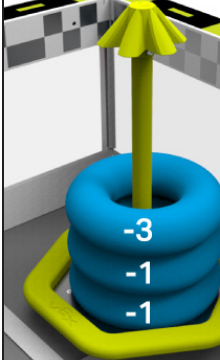
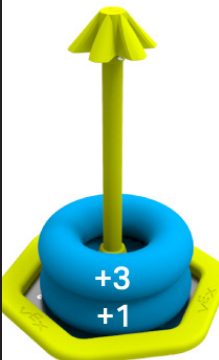
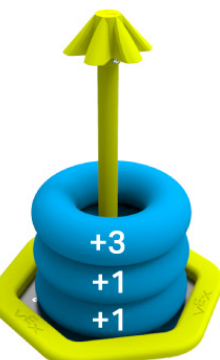

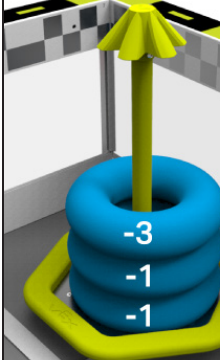
1. Compare the number of *Field Perimeter* segments contacted by the *Mobile Goal*; higher number is better.
2. A *Mobile Goal* that is contacting a white tape line ranks lower than one which is not.
3. A *Stake* that is roughly perpendicular to the *Floor* ranks higher than a *Stake* that is not as "vertical."
4. If criteria 1-3 are still tied, then neither *Mobile Goal* is considered *Placed*.

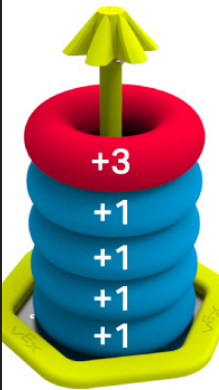

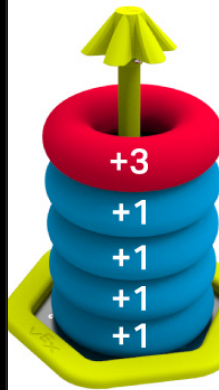
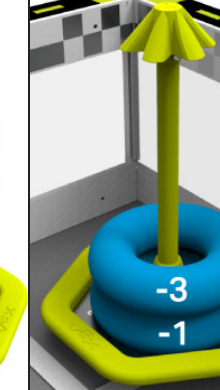
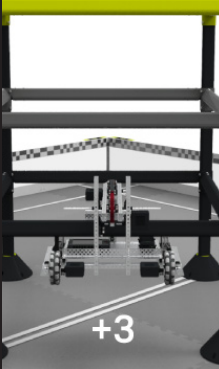
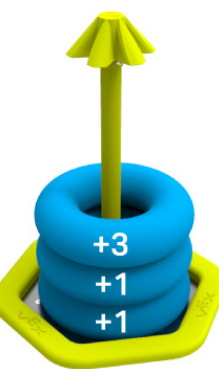
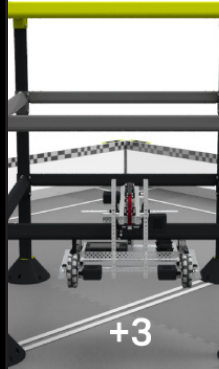
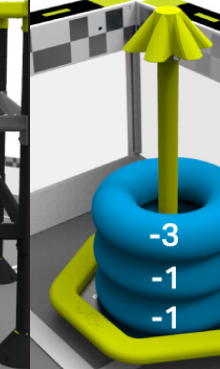
<SC6> A *Mobile Goal* that has been *Placed* will result in the following **Corner modifiers to its Scored Rings**:

- a. *Placed in a Positive Corner*
  - i. Values of all *Scored Rings* on the *Mobile Goal* will be doubled. *Scored Rings* will receive two (2) points, and *Scored Top Rings* will receive six (6) points.
- b. *Placed in a Negative Corner*
  - i. Values of all *Scored Rings* on the *Mobile Goal* will be set to zero points.

- ii. For each *Ring*, an equivalent amount of points will be removed from that *Alliance's* other *Scored Rings*. *Scored Rings* will remove (1) point, and *Scored Top Rings* will remove three (3) points.
- iii. This negator only applies to an *Alliance's* "Ring points." Points received for *Climbing* and the *Autonomous Bonus* cannot be removed.

*Note: The impact of Corner modifiers is subject to change in any of the major Game Manual updates (June 25, 2024; September 3, 2024; January 28, 2025; and/or April 2, 2025).*

Example	Before Negative Corner		After Negative Corner		Notes
	Stake 1	Stake 2	Stake 1	Stake 2	
1					Stake 2 was initially worth 5 points for the Blue Alliance, but is now worth negative 5 points after being moved into the Negative Corner.
	Blue: +6 Points	Blue: +5 Points	Blue: +6 Points	Blue: -5 Points	
2					Even though the net total is -1, you cannot have negative total points.
	Blue: +4 Points	Blue: +5 Points	Blue: +4 Points	Blue: -5 Points	

Example	Before Negative Corner		After Negative Corner		Notes
3	<b>Stake 1</b> 	<b>Stake 2</b> 	<b>Stake 1</b> 	<b>Stake 2</b> 	Even though the Blue Alliance has no <i>Top Rings</i> , the negative <i>Top Ring</i> still removes three points. Because none of the red Alliance's <i>Rings</i> are Scored in the <i>Negative Corner</i> , their points are not affected.
	Red: +3 Points Blue: +4 Points	Blue: +4 Points	Red: +3 Points Blue: +4 Points	Blue: -4 Points	Red: +3 Points Blue: 0 Points
4		<b>Stake 2</b> 		<b>Stake 2</b> 	<i>Corners</i> do not affect <i>Climb</i> or <i>Autonomous Bonus</i> Points.
	Blue: +3 Points	Blue: +5 Points	Blue: +3 Points	Blue: -5 Points	+3 Points

<SC7> A Robot is considered to have **Climbed to a Level** if it meets the following criteria:

- a. The *Robot* is contacting the *Ladder*.
- b. The *Robot* is not contacting any other *Field Elements*, including the gray foam tiles.
- c. The *Robot* is not contacting any *Mobile Goals*.
- d. The *Robot's* lowest point is past that *Level's* minimum height from the gray foam tiles.
  - i. Each *Level* corresponds to a vertical section of the *Ladder*. For example, a *Level 1 Climb* represents a *Robot* whose lowest point is above the foam tiles, but not higher than the black rung of the *Ladder*.



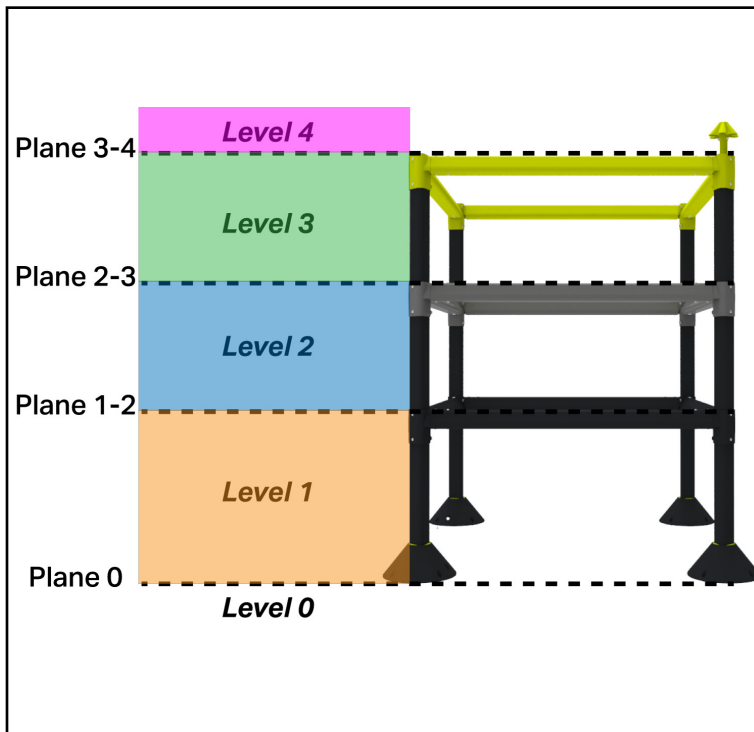


Figure SC7-1: A depiction of the different Levels and Planes of the Ladder

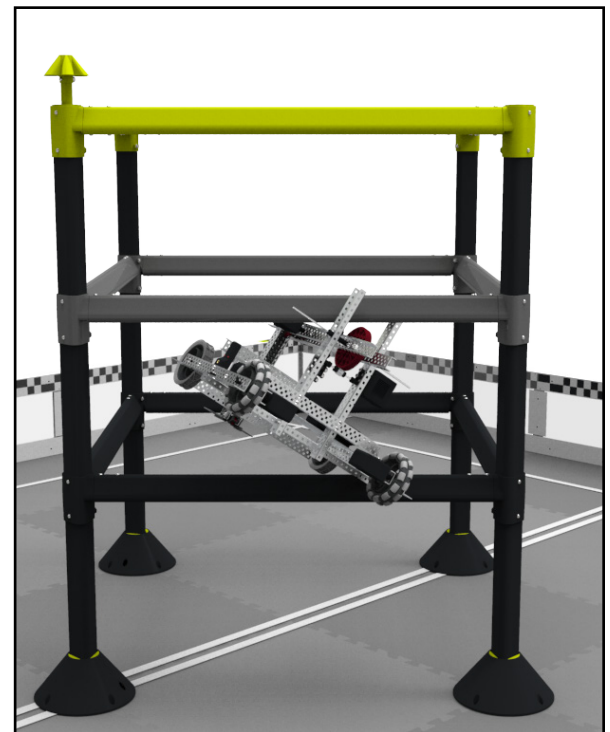


Figure SC7-2: This Robot is still in contact with the top of the black Ladder rung. Therefore, it would receive credit for a Level 1 Climb.

<SC8> An **Autonomous Win Point** is awarded to any *Alliance* that ends the *Autonomous Period* with the following tasks completed, and that has not broken any rules during the *Autonomous Period*:

1. At least three (3) *Scored Rings* of the *Alliance's* color
2. A minimum of two (2) *Stakes* on the *Alliance's* side of the *Autonomous Line* with at least (1) *Ring* of the *Alliance's* color *Scored*
3. Neither *Robot* contacting / breaking the plane of the *Starting Line*
4. At least one (1) *Robot* contacting the *Ladder*

This criteria will be slightly modified for events which qualify directly to the World Championship (e.g., Event Region Championships and Signature Events).

The modified criteria will be released in the September 3, 2024, Game Manual update. Any Championship-qualifying events held prior to this update will use the standard criteria listed in this rule.

The modification(s) will be minor, and will be intended to provide an increased challenge over the criteria listed above. For example, one possibility could be "four *Scored Rings* on any *Stake*" instead of three. The standard criteria for all other events will not change.

<SC9> A **High Stake bonus** is available to an *Alliance* that ends the *Match* with a *Ring Scored* on the High Stake. Each *Robot* from that *Alliance* which has earned points for a *Climb* will receive an additional two (2) points for that *Climb*.

# Safety Rules

**<S1> Be safe out there.** If at any time the *Robot* operation or *Team* actions are deemed unsafe or have damaged a *Field Element*, *Scoring Object*, or the *Field*, the offending *Team* may receive a *Disablement* and/or *Disqualification* at the discretion of the *Head Referee*. The *Robot* will require re-inspection as described in rule <R3> before it may take the field again.

**<S2> Students must be accompanied by an Adult.** No *Student* may attend a VEX V5 Robotics Competition event without a responsible *Adult* supervising them. The *Adult* must obey all rules and be careful to not violate *Student*-centered policies, but must be present for the full duration of the event in the case of an emergency. *Violations* of this rule may result in removal from the event.

**<S3> Stay inside the field.** If a *Robot* is completely out-of-bounds (outside the *Field*), it will receive a *Disablement* for the remainder of the *Match*.

*Note: The intent of this rule is not to penalize Robots for having mechanisms that inadvertently cross the Field Perimeter during normal game play.*

**<S4> Wear safety glasses.** All *Drive Team Members* must wear safety glasses or glasses with side shields while in the *Alliance Stations* during *Matches*. While in the pit area, it is highly recommended that all *Team* members wear safety glasses.

# General Game Rules

**<G1> Treat everyone with respect.** All *Teams* are expected to conduct themselves in a respectful and professional manner while competing in VEX V5 Robotics Competition events. If a *Team* or any of its members (*Students* or any *Adults* associated with the *Team*) are disrespectful or uncivil to event staff, volunteers, or fellow competitors, they may receive a *Disqualification* from a current or upcoming *Match*. *Team* conduct pertaining to <G1> may also impact a *Team's* eligibility for judged awards. Repeated or extreme violations of <G1> could result in a *Team* being *Disqualified* from an entire event, depending on the severity of the situation.

We all can contribute to creating a fun and inclusive event experience for all event attendees. Some examples include:

When dealing with difficult and stressful situations, it is...

- Okay for *Teams* to be gracious and supportive when your *Alliance* partner makes a mistake.
- Not okay for *Teams* to harass, tease, or be disrespectful to your *Alliance* partner when a *Match* does not go your way.

When a *Team* does not understand a *Match* ruling or score, it is...

- Okay for *Drive Team Members* to consult with a *Head Referee* to discuss a ruling per the process outlined in <T3> in a calm and respectful manner.
- Not okay for *Drive Team Members* to continue arguing with the *Head Referees* after a decision has been finalized, or for *Adults* to approach a *Head Referee* with ruling/scoring concerns.

When *Teams* are getting ready for an upcoming *Match*, it is...

- Okay for *Teams* in an *Alliance* to develop a game strategy that utilizes the strengths of both *Robots* to cooperatively solve the game.
- Not okay for *Teams* in an *Alliance* to intentionally play beneath their abilities to manipulate the *Match* results.

This rule exists alongside the REC Foundation Code of Conduct. *Violation* of the Code of Conduct can be considered a *Major Violation* of <G1> and can result in *Disqualification* from a current *Match*, an upcoming *Match*, an entire event, or (in extreme cases) an entire competition season. [The Code of Conduct can be found here.](#)

More information regarding the event Code of Conduct process [can be found here.](#)

*Violation Notes: Any Violation of <G1> may be considered Major Violations and should be addressed on a case-by-case basis. Teams at risk of a Major <G1> Violation due to multiple disrespectful or uncivil behaviors will usually receive a "final warning", although the Head Referee is not required to provide one.*

**<G2> V5RC is a student-centered program.** *Adults* may assist *Students* in urgent situations, but *Adults* may never work on or code a *Robot* without *Students* on that *Team* being present and actively participating. *Students* must be prepared to demonstrate an active understanding of their *Robot's* construction and code to judges or event staff.

Some amount of *Adult* mentorship, teaching, and/or guidance is an expected and encouraged facet of VEX competitions. No one is born an expert in robotics! However, obstacles should always be viewed as teaching opportunities, not tasks for an *Adult* to solve without *Students* present and actively participating.

When a mechanism falls off, it is...

- Okay for an *Adult* to help a *Student* investigate why it failed, so it can be improved.
- Not okay for an *Adult* to put the *Robot* back together.

When a *Team* encounters a complex coding concept, it is...

- Okay for an *Adult* to guide a *Student* through a flowchart to understand its logic.
- Not okay for an *Adult* to write a premade command for that *Student* to copy/paste.

During *Match* play, it is...

- Okay for an *Adult* to provide cheerful, positive encouragement as a spectator.
- Not okay for an *Adult* to explicitly shout step-by-step commands from the audience.

This rule operates in tandem with the REC Foundation Student Centered Policy, which is [available in the REC Library](#) for *Teams* to reference throughout the season.

*Violation Notes: Potential Violations of this rule will be reviewed on a case-by-case basis. By definition, all Violations of this rule become Match Affecting as soon as a Robot which was built or coded by an Adult wins a Match.*

**<G3> Use common sense.** When reading and applying the various rules in this document, please remember that common sense always applies in the VEX V5 Robotics Competition.

For example...

- If there is an obvious typographical error (such as "per <T5>" instead of "per <G5>"), this does not mean that the error should be taken literally until corrected in a future update.
- Understand the realities of the VEX V5 *Robot* construction system. For example, if a *Robot* could hover above the *Field* for a whole *Match*, that would create loopholes in many of the rules. But... they can't. So don't worry about it.
- When in doubt, if there is no rule prohibiting an action, it is generally legal. However, if you have to ask whether a given action would violate <S1>, <G1>, or <T1>, then that's probably a good indication that it is outside the spirit of the competition.

- In general, *Teams* will be given the “benefit of the doubt” in the case of accidental or edge-case rules infractions. However, there is a limit to this allowance, and repeated or strategic infractions will still be penalized.
- This rule also applies to *Robot* rules. If a component’s legality cannot be easily/intuitively discerned by the *Robot* rules as written, then *Teams* should expect additional scrutiny during inspection. This especially applies to those rules which govern non-VEX components (e.g. <R7>, <R8>, <R9>, etc.). There is a difference between “creativity” and “lawyering.” Basically, if there’s not a rule that makes a *Robot* part legal, it’s not allowed.

**<G4> The Robot must represent the skill level of the Team.** Each *Team* must include *Drive Team Members*, *Coder(s)*, *Designer(s)*, and *Builder(s)*. Many also include notebooker(s). No *Student* may fulfill any of these roles for more than one VEX V5 Robotics Competition *Team* in a given competition season. *Students* may have more than one role on the *Team*, e.g., the *Designer* may also be the *Builder*, the *Coder* and a *Drive Team Member*.

- Team* members may move from one *Team* to another for non-strategic reasons outside of the *Team*’s control.
  - Examples of permissible moves may include, but are not limited to, illness, changing schools, conflicts within a *Team*, or combining/splitting *Teams*.
  - Examples of strategic moves in *Violation* of this rule may include, but are not limited to, one *Coder* “switching” *Teams* in order to write the same program for multiple *Robots*, or one *Student* writing the Engineering Notebook for multiple *Teams*.
  - If a *Student* leaves a *Team* to join another *Team*, <G4> still applies to the *Students* remaining on the previous *Team*. For example, if a *Coder* leaves a *Team*, then that *Team*’s *Robot* must still represent the skill level of the *Team* without that *Coder*. One way to accomplish this would be to ensure that the *Coder* teaches or trains a “replacement” *Coder* in their absence.

Points ii and iii are intended to represent real-world situations that are found in industry engineering. If a vital member of a professional engineering team were to suddenly leave, the remaining members of the team should still be capable of working on / maintaining their project.

- When a *Team* qualifies for a Championship event (e.g., States, Nationals, Worlds, etc.) the *Students* on the *Team* attending the Championship event are expected to be the same *Students* on the *Team* that was awarded the spot. *Students* can be added as support to the *Team*, but may not be added as *Drive Team Members* or *Coders* for the *Team*.
  - An exception is allowed if only one member of the *Team* is able to attend the event. The *Team* can make a single substitution of a *Drive Team Member* or *Coder* for the Championship event with another *Student*, even if that *Student* has competed on a different *Team*. This *Student* will now be on this new *Team* and may not substitute back to the original *Team* during the season.

*Violation Notes: Violations of this rule will be evaluated on a case-by-case basis, in tandem with the REC Foundation Student Centered Policy as noted in <G2>, and the REC Foundation Code of Conduct as noted in <G1>.*

*Event Partners* should bear in mind <G3>, and use common sense when enforcing this rule. It is not the intent to punish a *Team* who may change *Team* members over the course of a season due to illness, changing schools, conflicts within a *Team*, etc.

*Event Partners* and referees are not expected to keep a roster of any *Student* who has ever been a *Drive Team Member* for one day. This rule is intended to block any instance of loaning or sharing *Team* members for the sole purpose of gaining a competitive advantage.

**<G5> Robots begin the Match in the starting volume.** At the beginning of a *Match*, each *Robot* must be smaller than a volume of 18" (457.2 mm) long by 18" (457.2 mm) wide by 18" (457.2 mm) tall.

*Note: Using external influences, such as preloads or the Field Perimeter, to maintain a Robot's starting size is only acceptable if the Robot would still satisfy the constraints of <R4> and pass inspection without these influences.*

*Violation Notes: Any Violation of this rule will result in the Robot being removed from the field prior to the start of the Match, and rules <R3d> and <T5> will apply until the situation is corrected.*

**<G6> Keep your Robots together.** *Robots* may not intentionally detach parts during the *Match* or leave mechanisms on the *Field*.

*Note: Parts which become detached unintentionally are a Minor Violation, are no longer considered "part of a Robot," and should be ignored for the purposes of any rules which involve Robot contact or location (e.g., Scoring) or Robot size.*

*Violation Notes: Major Violations of this rule should be rare, as Robots should never be designed to intentionally violate it. Minor Violations are usually due to Robots being damaged during gameplay, such as a wheel falling off.*

**<G7> Don't clamp your Robot to the Field.** *Robots* may not intentionally grasp, grapple, or attach to any *Field Elements* other than the *Ladder*. Strategies with mechanisms that react against multiple sides of a *Field Element* in an effort to latch or clamp onto said *Field Element* are prohibited. The intent of this rule is to prevent *Teams* from both unintentionally damaging the *Field* and/or from anchoring themselves to the *Field* in locations other than the *Ladder*.

*Violation Notes: Major Violations of this rule should be rare, as Robots should never be designed to intentionally violate it.*

**<G8> Only Drive Team Members, and only in the Alliance Station.** During a *Match*, each *Team* may have up to three (3) *Drive Team Members* in their *Alliance Station*, and all *Drive Team Members* must remain in their *Alliance Station* for the duration of the *Match*.

*Drive Team Members* are prohibited from any of the following actions during a *Match*:

- a. Bringing/using any sort of communication devices into the *Alliance Station*. Non-headphone devices with communication features turned off (e.g., a phone in airplane mode) are allowed.
- b. Standing on any sort of object during a *Match*, regardless of whether the *Field* is on the floor or elevated.
- c. Bringing/using additional materials to simplify the game challenge during a *Match*.
- d. To ensure that *Drive Team Members* are aware of verbal calls or warnings during a *Match* (as an application of rules <T1>, <G1>, <S1>, and <G3>), powered headphones, earbuds, and passive earpieces connected to electronic devices cannot be worn/used in the *Alliance Station* except as required by an officially approved accommodation request.

<G8c> is intended to refer to non-*Robot*-related items that directly influence gameplay, such as a speaker that plays a buzzer sound to distract your opponent. Provided no other rules are violated, and the items do not pose any safety or field damage risks, the following examples are not considered violations of <G8>:

- Materials used before or after a *Match*, such as a pre-*Match* alignment aid, or a carrying case for *Robots/Controllers*
- Strategic aids, such as a whiteboard or clipboard
- Earplugs, gloves, or other personal accessories

*Note: Drive Team Members are the only Team members that are allowed to be in the Alliance Station during a Match.*

*Note 2: During a Match, Robots may be operated only by the Drive Team Members and/or by software running on the Robot's control system, in accordance with <R27> and <G10>.*

*Violation Notes: Major Violations of this rule are not required to be Match Affecting, and could invoke Violations of other rules, such as <G1>, <G2>, or <G4>.*

**<G9> Hands out of the field.** *Drive Team Members* are prohibited from making intentional contact with any *Scoring Objects*, *Field Elements*, or *Robots* during a *Match*, apart from the contact specified in <G9a>.

- a. During the *Driver Controlled Period*, *Drive Team Members* may only touch their own *Robot* if the *Robot* has not moved at all during the *Match*. Touching the *Robot* in this case is permitted only for the following reasons:
  - i. Turning the *Robot* on or off
  - ii. Plugging in a battery
  - iii. Plugging in a V5 *Robot* Radio
  - iv. Touching the V5 *Robot* Brain screen, such as to start a program

- b. *Drive Team Members* are not permitted to break the plane of the *Field Perimeter* at any time during the *Match*, apart from the actions described above, or while reintroducing *Scoring Objects* to the *Field* as described in rule <SG4>
- c. Transitive contact, such as contact with the *Field Perimeter* that causes the *Field Perimeter* to contact *Field Elements* or *Scoring Objects* inside of the *Field*, could be considered a *Violation* of this rule.

*Note: Any concerns regarding Field Element or Scoring Object starting positions should be raised with the Head Referee prior to the Match. Team members may never adjust Scoring Objects or Field Elements themselves.*

**<G10> Controllers must stay connected to the field.** Prior to the beginning of each *Match*, *Drive Team Members* must plug their V5 Controller into the field's control system. This cable must remain plugged in for the duration of the *Match*, and may not be removed until the "all-clear" has been given for *Drive Team Members* to retrieve their *Robots*. See <T23> for more information regarding field control system options.

*Violation Notes: The intent of this rule is to ensure that Robots abide by commands sent by the tournament software. Temporarily removing the cable to assist with mid-Match troubleshooting, with an Event Partner or other event technical staff present and assisting, would not be considered a Violation.*

**<G11> Autonomous means "no humans."** During the *Autonomous Period*, *Drive Team Members* are not permitted to interact with the *Robots* in any way, directly or indirectly. This could include, but is not limited to:

- Activating any controls on their V5 Controllers
- Unplugging or otherwise manually interfering with the field connection in any way
- Manually triggering sensors (including the Vision Sensor) in any way, even without touching them

*Note: In extreme cases, with permission from the Head Referee, Teams may Disable their Robot during the Autonomous Period by holding the power button on their V5 Controller. This exception is only intended for egregious safety- or damage-related circumstances; disabling an autonomous routine for strategic purposes would still be considered a Violation of <G11>.*

*Violation Notes: See <G12>.*

**<G12> All rules still apply in the Autonomous Period.** Teams are responsible for the actions of their *Robots* at all times, including during the *Autonomous Period*. Any *Violations*, Major or Minor, during the *Autonomous Period* will result in the *Autonomous Bonus* being awarded to the other *Alliance*. If both *Alliances* violate rules during the *Autonomous Period*, no *Autonomous Bonus* will be awarded.

*Violation Note: In general, Minor Violations of SG rules that occur during the Autonomous Period should only affect the outcome of the Autonomous Period (i.e., the Alliance can't win the Autonomous Bonus or earn an Autonomous Win Point) and should not be considered when determining whether a Violation has been repeated during the event.*



*If a Head Referee determines that a Violation of an SG or G rule during the Autonomous Period was intentional/strategic rather than accidental/situational, they should be recorded as Minor or Major Violations and considered when determining whether a Violation has been repeated during the event..*

**<G13> Don't destroy other Robots.** But, be prepared to encounter defense. Strategies aimed solely at the destruction, damage, tipping over, or *Entanglement* of opposing *Robots* are not part of the ethos of the VEX V5 Robotics Competition and are not allowed.

- a. V5RC High Stakes is intended to be an offensive game. *Teams* that partake in solely defensive or destructive strategies will not have the protections implied by <G13> (see <G14>). However, defensive play which does not involve destructive or illegal strategies is still within the spirit of this rule.
- b. V5RC High Stakes is also intended to be an interactive game. Some incidental tipping, *Entanglement*, and damage may occur as a part of normal gameplay without *Violation*. It will be up to the *Head Referee's* discretion whether the interaction was incidental or intentional.
- c. A *Team* is responsible for the actions of its *Robot* at all times, including the *Autonomous Period*. This applies both to *Teams* that are driving recklessly or potentially causing damage, and to *Teams* that drive around with a small wheel base. A *Team* should design its *Robot* such that it is not easily tipped over or damaged by minor contact.

*Violation Notes:*

- *Major Violations of this rule are not required to be Match Affecting. Intentional and/or egregious tipping, Entanglement, or damage may be considered a Major Violation at the Head Referee's discretion.*
- *Repeated Violations within a Match or tournament could be considered a Violation of <G1> and/or <S1> at the Head Referee's discretion.*

**<G14> Offensive Robots get the "benefit of the doubt."** In a case where *Head Referees* are forced to make a judgment call regarding a destructive interaction between a defensive and offensive *Robot*, or an interaction which results in a questionable *Violation*, referees will decide in favor of the offensive *Robot*.

**<G15> You can't force an opponent into a penalty.** Intentional strategies that cause an opponent to break a rule are not permitted, and will not result in a *Violation* for the opposing *Alliance*.

*Violation Notes: In most cases, if a Team causes their opponent to break a rule, the Head Referee will simply not enforce the penalty on that opponent, and it will be considered a Minor Violation for the guilty Team. However, if the forced situation becomes Match Affecting in favor of the guilty Team, it will be considered a Major Violation.*

**<G16> No Holding for more than a 5-count.** A *Robot* may not *Hold* an opposing *Robot* for more than a 5-count during the *Driver Controlled Period*.

For the purposes of this rule, a “count” is defined as an interval of time that is approximately one second in duration, and “counted-out” by *Head Referees* verbally.

A *Holding* count is over when at least one of the following conditions is met:

- a. The two *Robots* are separated by at least two (2) feet (approximately one foam tile).
- b. Either *Robot* has moved at least two (2) feet away (approximately 1 tile) from the location where the *Trapping* or *Pinning* count began.
  - i. In the case of *Lifting*, this location is measured from where the *Lifted Robot* is released, not from where the *Lifting* began.
- c. The *Holding Robot* becomes *Trapped* or *Pinned* by a different *Robot*.
  - i. In this case, the original count would end, and a new count would begin for the newly Held *Robot*.
- d. In the case of *Trapping*, if an avenue of escape becomes available due to changing circumstances in the *Match*.

After a *Holding* count ends, a *Robot* may not resume *Holding* the same *Robot* again for another 5-count. If a *Team* resumes *Holding* the same *Robot* within that 5-count, the original count will resume from where it ended.

**<G17> Use Scoring Objects to play the game.** *Scoring Objects* may not be used to accomplish actions that would be otherwise illegal if they were attempted by *Robot* mechanisms. Examples include, but are not limited to:

- Interfering with an opponent’s Autonomous routine per <SG8>
- Interfering with an opponent’s *Climb* per <SG9>

The intent of this rule is to prohibit *Teams* from using *Rings* and *Mobile Goals* as “gloves” to loophole any rule that states “a *Robot* may not [do some action].” This rule is not intended to be taken in its most extreme literal interpretation, where any interaction between a *Scoring Object* and a *Robot* needs to be scrutinized with the same intensity as if it were a *Robot*.

*Violation Notes: If a rule is Violated through the use of a Scoring Object instead of a Robot mechanism, it should be evaluated as though the rule in question had been Violated by a Robot mechanism.*

# Specific Game Rules

**<SG1> Starting a Match.** Prior to the start of each *Match*, the *Robot* must be placed such that it is:

- Contacting / "breaking the plane" of their *Alliance's Starting Line*. See Figure SG1-1.
- Not contacting any *Scoring Objects* other than a maximum of one (1) preload. See rule <SG5>.
- Not contacting any other *Robots*.
- Completely stationary (i.e., no motors or other mechanisms in motion).

*Violation Notes: The Match will not begin until the conditions in this rule are met. If a Robot cannot meet these conditions in a timely manner, the Robot will be removed from the Field and rules <R3d> and <T5> will apply until the situation is corrected.*

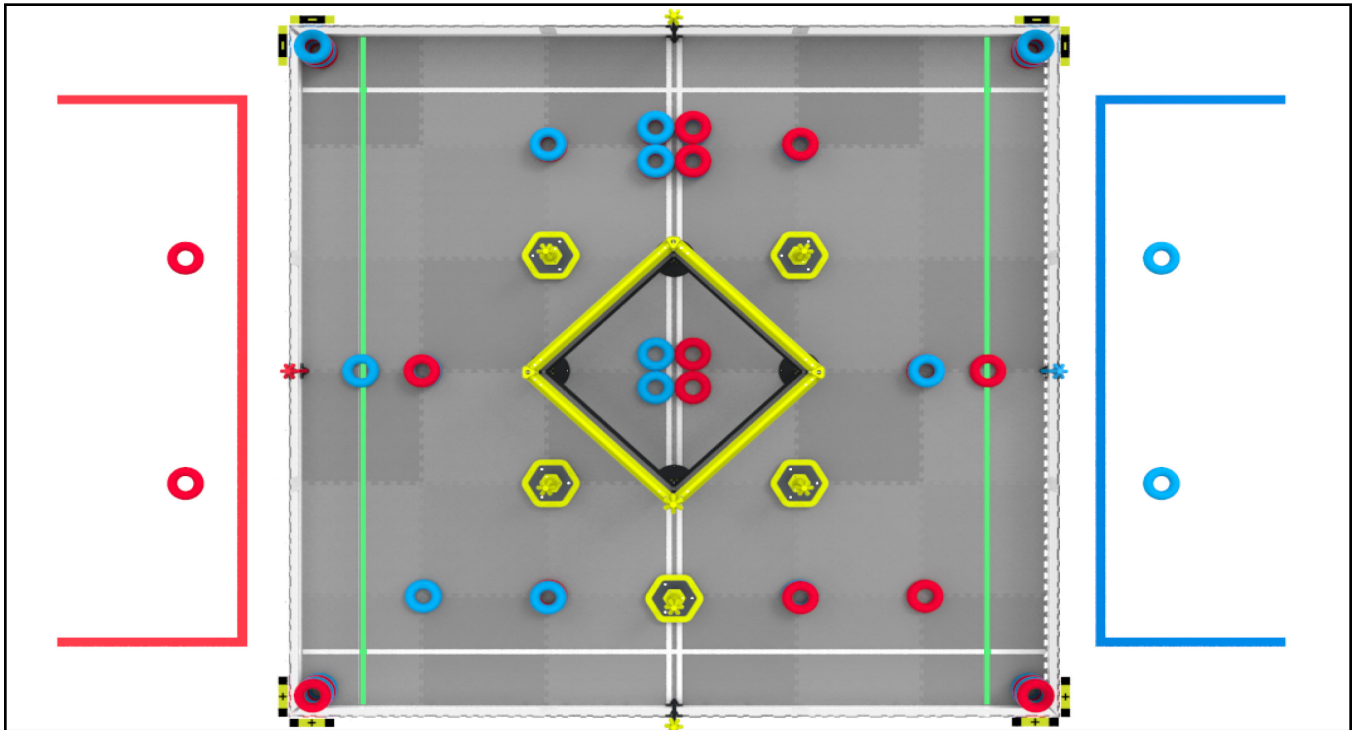


Figure SG1-1: An overhead view of the Field, with the Starting Lines highlighted green.

**<SG2> Horizontal expansion is limited.** Once the *Match* begins, *Robots* may only expand beyond their starting size and configuration within the following criteria:

- Robots* may never exceed an overall footprint of 24" x 18". For reference, 24" is roughly the width of one foam field tile.
- From the *Robot's* perspective, only one "X/Y" direction may expand outside of the starting configuration during the *Match* (i.e., the *Robot* can't get both wider and longer). This single expansion direction must be identified and measured during *Robot* inspection, as shown in the figures below.
- Vertical expansion is addressed separately by rule <SG3>. *Robots* may expand both horizontally and vertically; the top of the *Robot* is not considered an "X/Y" direction in the context of this rule.

*Note: Horizontal expansion is measured from the Robot's perspective; i.e., it **does** "rotate with the Robot." Robots that tip over, or rotate while Climbing, are still restricted to expanding "from the one side" in the chosen direction that was measured during inspection.*

The intent of this rule is to limit horizontal expansion in a way that can be easily interpreted by *Head Referees* during a *Match* and assessed by *Robot* inspectors.

For example, a *Robot* can expand a mechanism in a single direction up to a 24" maximum size, but cannot expand a *Mobile Goal* manipulator from one side and a *Ring* manipulator from another (unless one of those is already identified and extended as part of the *Robot's* inspected starting configuration).

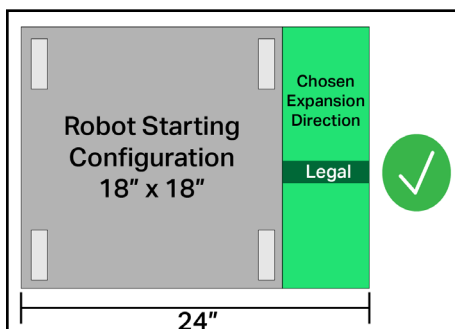
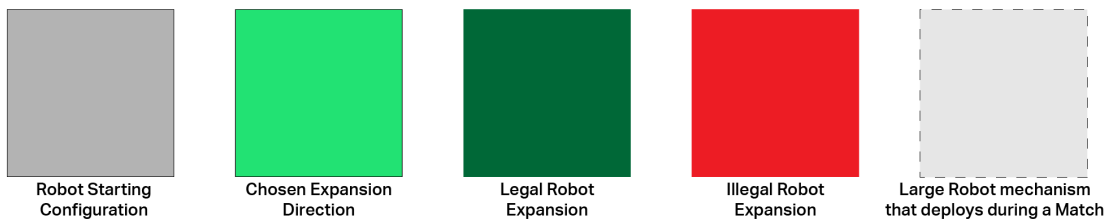
The figures below do not provide an exhaustive list of all possible *Robot* configurations and expansions, and should serve as examples to provide some clarity about the intent of this rule.

*Violation Notes: Incidental minor infractions out of non-expansion sides that occur during a Match are only considered Minor Violations. Repeated Minor Violations should only escalate to a Major Violation in extreme circumstances. Examples include, but are not limited to:*

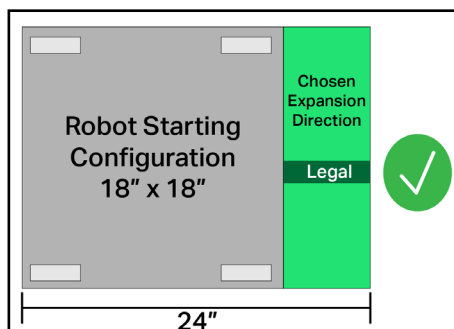
- *Loose wires*
- *Broken zip ties / rubber bands*
- *Bent or broken mechanical components that are not used for strategic gain*

Significant Q&As:

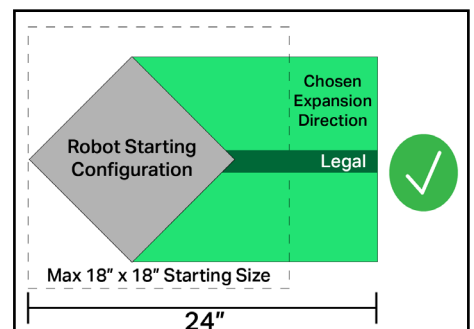
- [2006](#) - The Robot's size includes the entire Robot, including decorations and cables
- [2036](#) - Horizontal expansion rotates with the Robot, even during climbing



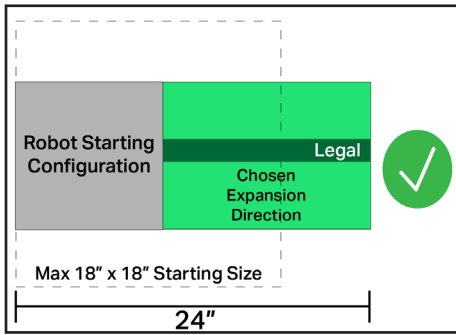
**Figure SG2-1:** This is legal. The Robot is expanding 6" outside of the legal 18" x 18" starting size in the chosen direction.



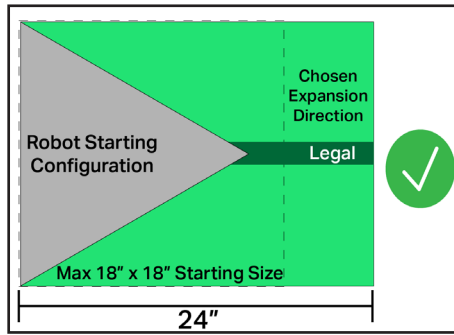
**Figure SG2-2:** This is legal. The Robot is expanding 6" outside of the legal 18" x 18" starting size in the chosen direction.



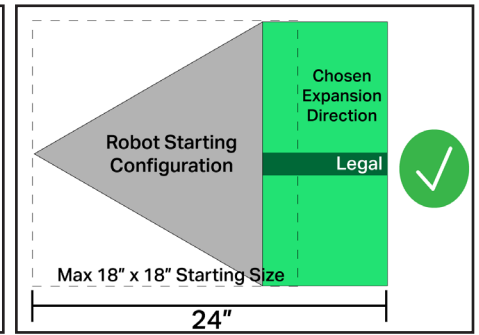
**Figure SG2-3:** This is legal. Even though the Robot does not fill the full 18" x 18" starting size, it may still expand outwards to the full 24" limit in the chosen direction.



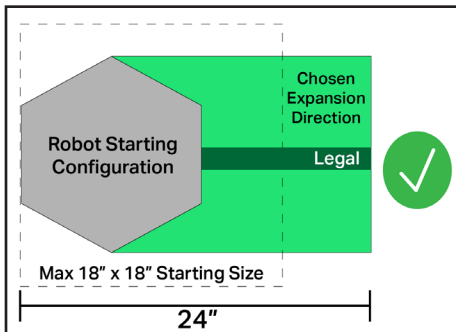
**Figure SG2-4:** This is legal. Even though the Robot does not fill the full 18" x 18" starting size, it may still expand outwards to the full 24" limit in the chosen direction.



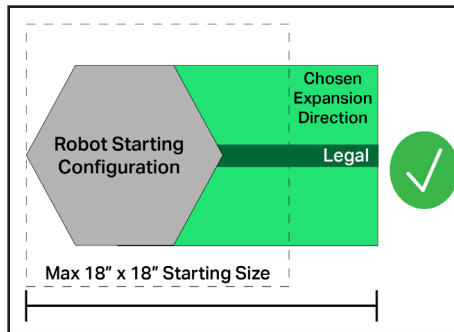
**Figure SG2-5:** This is legal. Even though the Robot does not fill the full 18" x 18" starting size, it may still expand outwards to the full 24" limit in the chosen direction.



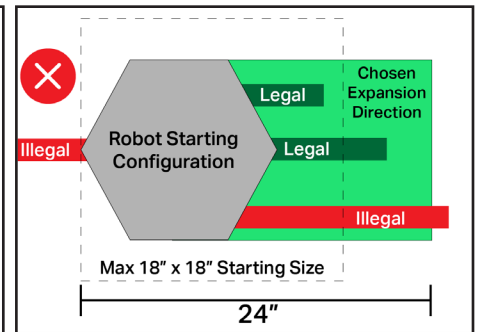
**Figure SG2-6:** This is legal. Even though the Robot does not fill the full 18" x 18" starting size, it may still expand outwards to the full 24" limit in the chosen direction.



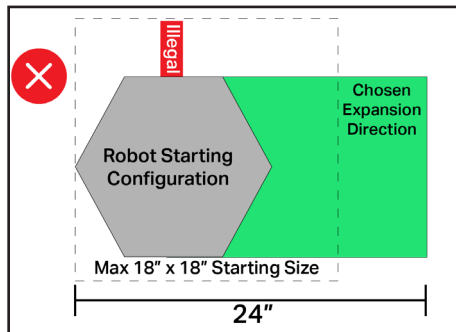
**Figure SG2-7:** This is legal. Even though the Robot does not fill the full 18" x 18" starting size, it may still expand outwards to the full 24" limit in the chosen direction.



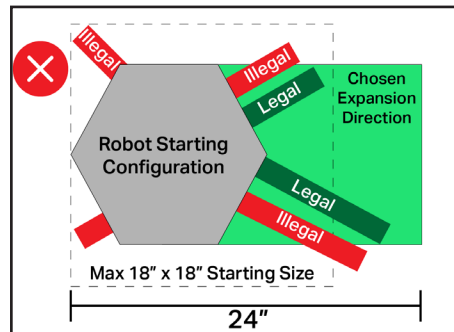
**Figure SG2-8:** This is legal. Even though the Robot does not fill the full 18" x 18" starting size, it may still expand outwards to the full 24" limit in the chosen direction.



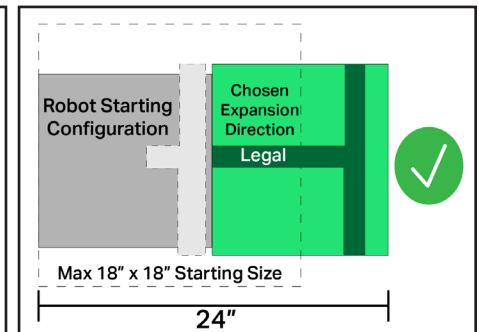
**Figure SG2-9:** This is not legal. The Robot is expanding outside of the 24" limit, and is also expanding in a direction other than the chosen expansion direction.



**Figure SG2-10:** This is not legal. The Robot is expanding in a direction other than the chosen expansion direction.

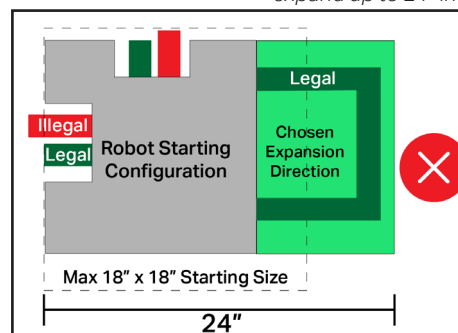
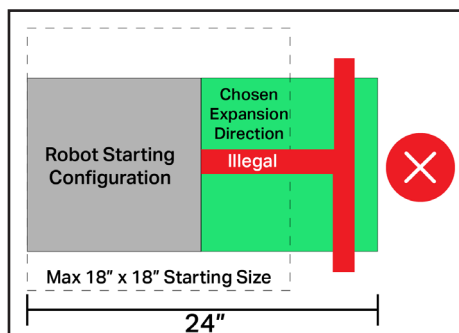


**Figure SG2-11:** This is not legal. The Robot is expanding in a direction other than the chosen expansion direction.



**Figure SG2-12:** This is legal. The Robot deploys a mechanism during the Match that fits within the 18" x 18" starting size. It may then expand up to 24" in the chosen direction.

**Figure SG2-13:** This is not legal. The Robot expands outside of the starting configuration in multiple directions.



**Figure SG2-14:** This is not legal. The Robot expands outside of the starting configuration in multiple directions.

**<SG3> Vertical expansion is limited.** Once the *Match* begins, *Robots* may expand vertically, but may never contact and/or “break the plane” of more than two *Levels* of the *Ladder* at any given time.

- a. For a *Robot* that is on the *Floor* (i.e., not *Climbing*), this is effectively a height limit of 32”, the distance between the *Floor* and the top of the gray rung of the *Ladder*.
- b. This vertical limit is measured from the perspective of the *Field*; i.e., it **does not** “rotate with the *Robot*.”
- c. *Levels* and *Planes* coincide with the horizontal and vertical dimensions of the *Ladder* rungs, but expand infinitely and are not limited to the volume of the *Ladder*.
  - i. Each *Level* corresponds to a vertical section of the *Ladder*.
    - o Level 0: 0”, the *Floor* tiles
    - o Level 1: less than 18.16”, from the *Floor* to the top of the black rung
    - o Level 2: 18.17”-32.16”, from the top of the black rung to the top of the gray rung
    - o Level 3: 32.17: to 46.16 inches, from the top of the gray rung to the top of the yellow rung
    - o Level 4: ≥46.17 inches, above the yellow rung
  - ii. Each *Plane* marks the dividing line between two *Levels*.
    - o *Plane* 0: *Floor* tiles
    - o *Plane* 1-2: top edge of the black rung of the *Ladder*
    - o *Plane* 2-3: top edge of the gray rung of the *Ladder*
    - o *Plane* 3-4: top edge of the yellow rung of the *Ladder*

The intent of this rule is to prohibit *Teams* from “skipping a *Level*”. It is impossible to contact or “break the *Plane*” of three *Levels*, or two non-sequential *Levels*, without violating this rule.

*Violation Notes: If a Robot falls or “drips” after the Match ends and leads to an <SG3> Violation, this will likely be considered a Minor Violation, provided no other rules are Violated. Their Climb will be scored where they come to rest; see <SC1>.*

**<SG4> Keep Scoring Objects in the field.** *Teams* may not intentionally or strategically remove *Scoring Objects* from the field. *Rings* that leave the *Field* during *Match* play, intentionally or unintentionally, will be given to *Drive Team Members* from the same color *Alliance* as the *Ring*. These *Drive Team Members* may gently place them into the field such that they satisfy the following conditions:

- a. Contacting the *Field Perimeter* wall on the side that coincides with their *Alliance Station*.
- b. Contacting the *Floor*.
- c. Not contacting a *Mobile Goal*.
- d. Not contacting a *Robot*.
- e. Not contacting a *Corner*.

Note: It is expected that Drive Team Members may momentarily break the plane of the Field while legally introducing these Rings. Teams from both Alliances should be extremely mindful of <S1> and <G9> during this process.

Note 2: If a Mobile Goal leaves the Field, it should be returned to the field in a neutral/non-Placed state. Any Rings which were scored on this Mobile Goal will be given to their respective Drive Team Members, as described above.

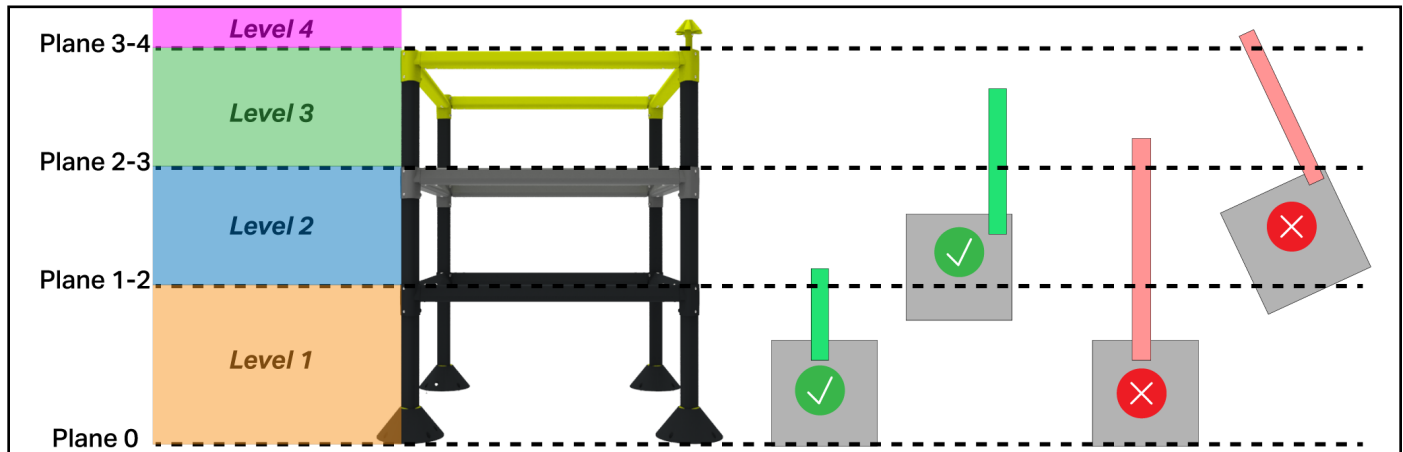


Figure SG3-1: Examples of legal and illegal vertical expansion.

#### Violation Notes:

- After a Team's third Violation of this rule (either Major or Minor), all subsequent Violations of this rule will immediately escalate to a Major Violation.
- Any Team that removes three (3) or more Rings from the Field in a single Match will receive a Major Violation.
- If it is not clear which Robot was the last to contact the Ring, then the Minor Violation will apply to all Teams involved with the interaction.
- Due to the difficulty of determining Match Affecting implications of this rule, most Violations should be considered Minor. However, blatantly intentional and/or Match Affecting Violations (especially during Elimination Matches) may still immediately escalate to a Major Violation at the Head Referee's discretion. For example, a Top Ring that is removed with 5 seconds remaining by an Alliance who wins the Match by 1 point.
- Any Team who removes a Mobile Goal from the field will immediately receive a Major Violation.

#### Significant Q&As:

- [2059](#) - Removing Rings from the Field while descoring is a Violation

<SG5> **Each Robot gets one Ring as a preload.** Prior to the start of each Match, each preload that is used must be placed such that it is:

- Contacting one Robot of the same Alliance color as the preload.
- Not contacting the same Robot as another preload.

- c. Not contacting or encircling a *Stake* or any other *Scoring Objects*.

*Note: If a Robot is not present for their Match, then that Robot's preload may be placed prior to the Match such that it satisfies the criteria listed in <SG4>.*

*Violation Notes: See <SG1>.*

**<SG6> Possession is limited to two Rings and/or one Mobile Goal.** Robots may not have Possession of more than two (2) *Rings* and/or one (1) *Mobile Goal* at once. Robots in Violation of this rule must immediately stop all actions except for attempting to remove the excess *Scoring Objects*.

If they are unable to remove the excess *Scoring Objects*, then they must return to a legal starting position (as described by <SG1>). They will not be eligible to receive points for *Climbing*. Any offensive or defensive interactions with *Mobile Goals*, *Stakes*, and *Corners* will be included in *Match Affecting* calculations.

- Rings* on a *Stake* are not included in a *Robot's Possession* count. For the purposes of this rule, "on a *Stake*" means that the *Ring* meets the criteria for a *Scored Ring*, even if it is being contacted by a *Robot*.
- Plowing* multiple *Mobile Goals* is permitted. However, *Plowing* an additional *Mobile Goal* while also *Possessing* one is considered a *Violation* of this rule due to the extremely high likelihood of accidental/implied *Possession*. *Teams* which employ *Plowing* strategies are encouraged to clearly demonstrate that none of the *Mobile Goals* are being *Possessed*, e.g., by using a flat face of the *Robot* with no active mechanisms.

*Violation Notes:*

*Any egregious or clearly intentional Violation by an Alliance who wins the Match will be considered a Major Violation. Examples of "clearly intentional" Violations include, but are not limited to:*

- Possessing two or more Mobile Goals in a single Corner.*
- Continuing to play other portions of the game (e.g., defensive maneuvers, Climbing) without returning to a starting position for the majority of the Match.*
- "Accidentally" Possessing an egregious amount of opponent Rings.*
- Possessing six Rings, and Scoring them onto one Stake with a single action.*
- "Removing excess Scoring Objects" directly into Placed/Scored states.*

Significant Q&As:

- [2011](#) - Any Ring(s) removed from a Stake can count toward Possession
- [2013](#) - Guarding a Mobile Goal isn't the same as Possessing (or Plowing) it
- [2026](#) - Possession is not transitive through other Robots



**<SG7> Don't cross the Autonomous Line.** During the *Autonomous Period*, Robots may not contact foam tiles, Scoring Objects, or Field Elements which are on the opposing Alliance's side of the Autonomous Line.

*Note: Scoring Objects and Wall Stakes that contact or are positioned above the Autonomous Line are not considered to be on either side, and may be utilized by either Alliance during the Autonomous Period.*

*Violation Notes:*

- All Violations of this rule (Major or Minor) will result in the Autonomous Bonus being awarded to the opposing Alliance. See <SG8b> for a potential exception caused by Autonomous Line interactions.
- Intentional, strategic, or egregious Violations, such as intentional contact with an opposing Robot while contacting the foam tiles on the opposing side of the Autonomous Line, will be considered Major Violations.

**<SG8> Engage with the Autonomous Line at your own risk.** Any Robot who engages with Scoring Objects and/or Wall Stakes on the Autonomous Line should be aware that opponent Robots may also choose to do the same. Per <G11> and <G12>, Teams are responsible for the actions of their Robots at all times.

During the *Autonomous Period*, when Robots from opposing Alliances are both engaged with the same Scoring Object or Wall Stake:

- If a possible <G13> Violation occurs (e.g., damage, Entanglement, or tipping over), a judgment call will be made by the Head Referee within the context of <G13> and <G14> (just as it would if the interaction had occurred during the *Driver Controlled Period*).
- Incidental Violations of <SG7> will not be penalized, nor will they result in an automatic loss of the *Autonomous Bonus* as described by <G12>. However, this allowance only applies when opposing Robots are interacting with the same element.
- Intentional, strategic, repeated, or egregious offenses may still be deemed a Violation of <G12>, <G13>, <G14>, <SG7>, <G1>, and / or <S1> at the Head Referee's discretion.

These gameplay elements are intended to be utilized by either Alliance during the *Autonomous Period*. This will inevitably result in Robot-on-Robot interactions, both incidental and intentional. The overarching intent of <SG8> is for the vast majority of these interactions to result in no rule Violations and/or penalties for either Alliance, just as no rules Violations occur in 99% of Driver Controlled interactions.

**<SG9> Don't remove opponents from the Ladder.** There are no rules explicitly prohibiting incidental contact between *Climbing Robots*. However, if contact does occur, the principles behind rules <G13>, <G14>, and <G15> still apply. Intentional or egregious strategies aimed solely at damage or tipping are not allowed (in this context, "tipping" can be equated with "removing an opponent from the *Ladder*"). *Teams* cannot negate an opponent's *Climb* by contacting their *Robot* with a *Mobile Goal*, and an affected *Climb* will still be *Scored*. Doing so will result in a *Minor Violation* for the offending *Team*, assuming no other rules are broken and no damage is caused to the opponent.

The core intent of this rule is the paragraph above. Everything that follows this red box is meant to provide guidance for interpreting questionable/incidental interactions, similar to how <G14> is used for ground level interactions. These are not explicit/absolute "hard lines" that supersede an obvious *Violation*. If a *Robot* has a mechanism designed to violently kick opponents off of the *Ladder*, none of the factors below can protect them.

If a destructive incident occurs that requires a *Head Referee* judgment call between two *Robots*, the following factors may be used to determine "benefit of the doubt".

- a. If the two *Robots* are not at the same *Level*, the higher *Robot* has the "right of way."
  - i. Point A especially applies if one *Robot* is not *Climbing*, i.e., is still in contact with the *Floor*. Driving directly into a *Climbing Robot* will always incur a *Minor Violation* at a minimum, even if no damage occurs.
- b. If a *Robot* is contacting the horizontal rungs of the *Ladder* facing their *Alliance Station*, they should generally be considered in a more "offensive" or "safe" position.
- c. *Teams* are responsible for their own *Robots*. *Climbing* mechanisms should be robust. If a *Robot* is not firmly attached to the *Ladder*, or has a history of falling without any opponent interaction, it will be difficult to claim that later damage was an opponent's fault.
- d. *Teams* should expect possible interaction between *Robots* when engaging with the High Stake. These interactions will be treated similarly as two *Robots* engaging with the *Autonomous Line* in <SG8>; other than repeated/egregious cases, this contact/damage is likely to be ruled incidental.

*Teams* can use this rule as a gradient of "risk tolerance" when designing *Climbing* mechanisms or playing *Matches*.

- Low risk = Be the first *Robot* up, have a robust build, stay on your side of the *Ladder*, avoid the High Stake. Low chance of interacting with others intentionally or accidentally.
- High risk = Last-second dash up to de-score the High Stake. Technically possible to accomplish legally, but you're not allowed to be surprised when an accident is not ruled in your favor.

#### *Violation Notes:*

- *This rule exists as an application of <G13> that is specific to Climbing. Violations should be treated effectively the same as Violations of <G13>.*
- *As with <G13>, Major Violations are not required to be Match Affecting, at the Head Referee's discretion.*

**<SG10> Alliance Wall Stakes are protected.** Robots may not directly or indirectly interact with the opponent's *Alliance Wall Stake*. This includes both *Scoring* and/or removing *Rings* of either color. For the purposes of this rule, "Score" (and "remove") means causing them to satisfy (or no longer satisfy) the criteria listed in <SC3>.

If a *Ring* of the opposing color ends the *Match* in a *Scored* position on an *Alliance Wall Stake*, that *Ring* should not be considered as *Scored*, and will not earn points for either *Alliance* (it will still, however, count toward the maximum number of 2 *Rings* that can be placed on an *Alliance Wall Stake*).

**<SG11> Positive corners are "safe" during the endgame.** During the last ten (10) seconds of a *Match*, Robots may not contact *Mobile Goals* that are *Placed* in the *Positive Corners* of the *Field*, may not contact *Rings* that are *Scored* on *Mobile Goals Placed* in the *Positive Corners* of the *Field*, and may not *Place* or *Score* additional *Mobile Goals* or *Rings* in the *Positive Corners* of the *Field*.

# Section 3

## The Robot

### Overview

This section provides rules and requirements for the design and construction of your *Robot*. A VEX V5 Robotics Competition *Robot* is a remotely operated and/or autonomous vehicle designed and built by a registered VEX V5 Robotics Competition *Team* to perform specific tasks.

There are specific rules and limitations that apply to the design and construction of your *Robot*. Please ensure that you are familiar with these *Robot* rules before beginning your *Robot* design. These "inspection rules" are verified prior to the beginning of each event, in a formal *Robot* Inspection.

Inspection Rules are "pass/fail"; there are no *Major* or *Minor Violations*, only *Violations*. The penalty for all *Violations* is the same, as outlined in <R3d> and <R28>.

Most of these rules are "hard limits," such as the maximum number of motors permitted. However, some are "at inspector discretion," such as determining a mechanism's potential safety risk. At many events, the lead inspector and the *Head Referee* are the same person; if they are not, then the volunteer inspector should confirm any questionable judgment calls with the *Head Referee*. The *Head Referee* has final authority regarding all *Robot* rules, since it is ultimately their decision whether a *Robot* takes the field for a *Match* after inspection has concluded (per <R3d> and <R3e>).

### Inspection Rules

**<R1> One Robot per Team.** Only one (1) *Robot* will be allowed to compete per *Team* at a given event in the VEX V5 Robotics Competition. Though it is expected that *Teams* will make changes to their *Robot* at the competition, a *Team* is limited to only one (1) *Robot* at a given event. A VEX *Robot*, for the purposes of the VEX V5 Robotics Competition, has the following subsystems:

- Subsystem 1: Mobile robotic base including wheels, tracks, legs, or any other mechanism that allows the *Robot* to navigate the majority of the flat playing field surface. For a stationary *Robot*, the robotic base without wheels would be considered Subsystem 1.
- Subsystem 2: Power and control system that includes a legal VEX battery, a legal VEX control system, and associated motors for the mobile robotic base.
- Subsystem 3: Additional mechanisms (and associated motors) that allow manipulation of *Rings*, *Field Elements*, or *Climbing the Ladder*.

Given the above definitions, a minimum *Robot* for use in any VEX V5 Robotics Competition event (including Skills Challenges) must consist of subsystems 1 and 2 above. Thus, if you are swapping out an entire subsystem 1 or 2, you have now created a second *Robot* and have *Violated* this rule.

- Teams* may not compete with one *Robot* while a second is being modified or assembled at a competition.
- Teams* may not have an assembled second *Robot* on-hand at a competition that is used to repair or swap parts with the first *Robot*.

- c. *Teams* may not switch back and forth between multiple *Robots* during a competition. This includes using different *Robots* for Skills Challenges, *Qualification Matches*, and/or *Elimination Matches*.
- d. Multiple *Teams* may not use the same *Robot*. Once a *Robot* has competed under a given *Team* number at an event, it is “their” *Robot*; no other *Teams* may compete with it.

The intent of <R1a>, <R1b>, and <R1c> is to ensure an unambiguous level playing field for all *Teams*. *Teams* are welcome (and encouraged) to improve or modify their *Robots* between events, or to collaborate with other *Teams* to develop the best possible game solution.

However, a *Team* who brings and/or competes with two separate *Robots* at the same tournament has diminished the efforts of a *Team* who spent extra design time making sure that their one *Robot* can accomplish all of the game’s tasks. A multi-*Team* organization that shares a single *Robot* has diminished the efforts of a multi-*Team* organization who puts in the time, effort, and resources to undergo separate individual design processes and develop their own *Robots*.

To help determine if a *Robot* is a “separate *Robot*” or not, use the subsystem definitions found in <R1>. Above that, use common sense as referenced in <G3>. If you can place two *Robots* on a table next to each other, and they look like two separate legal/complete *Robots* (i.e., each has the 3 subsystems defined by <R1>), then they are two *Robots*. Trying to decide if changing a screw, a wheel, or a microcontroller constitutes a separate *Robot* is missing the intent and spirit of this rule.

**<R2> Robots must represent the Team’s skill level.** The *Robot* must be designed, built, and programmed by members of the *Team*. *Adults* are expected to mentor and teach design, building, and Programming Skills to the *Students* on the *Team*, but may not design, build, or program that *Team’s* *Robot*. See rules <G2> and <G4>.

In V5RC, we expect *Adults* to teach fundamental *Robot* principles like linkages, drive-trains, and manipulators, then allow the *Students* to determine which designs to implement and build on their *Robot*.

Similarly, *Adults* are encouraged to teach the *Students* how to code various functions involving applicable sensors and mechanisms, then have the *Students* program the *Robot* from what they have learned.

**<R3> Robots must pass inspection.** Every *Robot* will be required to pass a full inspection before being cleared to compete. This inspection will ensure that all *Robot* rules and regulations are met. Initial inspections will take place during team registration/practice time. Noncompliance with any *Robot* design or construction rule will result in removal from *Matches* or *Disqualification* of the *Robot* at an event until the *Robot* is brought back into compliance, as described in the following subclauses.

- a. Significant changes to a *Robot*, such as a partial or full swap of Subsystem 3, must be re-inspected before the *Robot* may compete again.
- b. All possible functional *Robot* configurations must be inspected before being used in competition. This especially pertains to modular or swappable mechanisms (per <R1>) and *Match* starting configurations/sizes (per <R4>).
- c. *Teams* may be requested to submit to spot inspections by *Head Referees*. Refusal to submit will result in *Disqualification*.
  - i. If a *Robot* is determined to be in *Violation* of a *Robot* rule before a *Match* begins, the *Robot* will be removed from the *Field*. A *Drive Team Member* may remain at the *Field* so that the *Team* does not get assessed a “no-show” (per <T5>).
- d. *Robots* which have not passed inspection (i.e., that may be in *Violation* of one or more *Robot* rules) will not be permitted to play in any *Matches* until they have done so. <T5> will apply to any *Matches* that occur until the *Robot* has passed inspection.
- e. If a *Robot* has passed inspection, but is later confirmed to be in *Violation* of a *Robot* rule during or immediately following a *Match* by a *Head Referee*, they will be *Disqualified* from that *Match*. This is the only *Match* that will be affected; any prior *Matches* that have already been completed will not be revisited. <R3d> will apply until the *Violation* is remedied and the *Team* is re-inspected.
- f. All Inspection Rules are to be enforced within the discretion of the *Head Referee* within a given event. *Robot* legality at one event does not automatically imply legality at future events. *Robots* which rely on “edge-case” interpretations of subjective rules, such as whether a decoration is “non-functional” or not, should expect additional scrutiny during inspection.

**<R4> Robots must fit within an 18" x 18" x 18" volume.**

- a. Compliance with this rule must be checked using the official [VEX Robotics On-Field Robot Expansion Sizing Tool](#).
- b. Any restraints used to maintain starting size (i.e., zip ties, rubber bands, etc.) must remain attached to the *Robot* for the duration of the *Match*, per <G6>.
- c. For the purposes of this rule, it can be assumed that *Robots* will be inspected and begin each *Match* on a flat standard foam field tile.

The official sizing tool is intentionally manufactured with a slightly oversized tolerance. Therefore, any contact with the sizing tool (i.e., a “paper test”) while being measured should be considered a clear indication that a *Robot* is outside of the permitted size. This tolerance also provides a slight “leeway” for minor protrusions, such as screw heads or zip ties.

Other tools, such as custom sizing boxes or the legacy non-expanding VEX Sizing Tool (276-2086), may be used for informal checks. However, in the event of a conflict or “close call,” a check with the official On-Field Robot Expansion Sizing Tool takes precedence.

**<R5> Robots may only expand horizontally in one direction.** Robots who choose to expand horizontally must demonstrably meet all criteria listed in rule <SG2>. The configuration / "expansion direction" that is measured during inspection must also be the direction used during *Match* play.

**<R6> Robots must be safe.** The following types of mechanisms and components are NOT allowed:

- a. Those that could potentially damage *Field Elements* or *Scoring Objects*.
- b. Those that could potentially damage other competing *Robots*.
- c. Those that pose an unnecessary risk of *Entanglement* with other *Robots* or *Field Elements*.
- d. Those that could pose a potential safety hazard to *Drive Team Members*, event staff, or other humans.

**<R7> Robots are built from the VEX V5 system.** Robots may be built ONLY using official VEX V5 components, unless otherwise specifically noted within these rules. Product pages on the VEX Robotics website should be used as the official definitive source for determining if a product is a "V5 component."

- a. Products from the VEXpro, VEX EXP, VEX IQ, VEX GO, VEX 123, VEX CTE, VEX AIM, VEX AIR, or VEX Robotics by HEXBUG\* product lines cannot be used for *Robot* construction, unless specifically allowed by a clause of <R7> or "cross-listed" as part of the VEX V5 Product lines. For example, Flex Wheels and VersaHubs are VEXpro components that can be found on the VEX "[Flex Wheels](#)" page, and specific sizes are thus legal.

\* The HEXBUG brand is a registered trademark belonging to Spin Master Corp

- b. The following electronics from the VEX Cortex control system are not permitted:

SKU	Description
276-2192	VEXnet Joystick
276-1891	VEXnet Partner Joystick
276-2194	VEX ARM® Cortex-based Microcontroller
276-2245 / 276-3245	VEXnet Key 1.0 / 2.0
276-2177	2-Wire Motor 393
276-2162	3-Wire Servo
276-2210	VEX Flashlight
276-2193	Motor Controller 29

- c. The following electronics from the VEX Cortex control system are permitted:

SKU	Description
276-2174 / 276-4859	Limit Switch V1 / V2
276-2159	Bumper Switch
276-2156	Optical Shaft Encoder
276-2216	Potentiometer
276-2155	Ultrasonic Range Finder
276-2176	LED Indicator

276-2333	Yaw Rate Gyroscope
276-2332	Analog Accelerometer V1.0
276-2154	Line Tracker
276-1380	Jumper
276-2158	Light Sensor

- d. Components that are unique to the V5 Workcell / CTE product line are not permitted. This includes the following:

SKU	Description
276-7151	Robot Arm Metal
276-7152	Robot Brain Mount
276-7153	Input Output Conveyor
276-7720	Disc Feeder
276-7047	V5 Electromagnet

- e. VEX IQ pins are permitted.
- f. Components obtained from the V5 beta program, including V5 beta firmware, are not legal for competition use.
- i. All V5 beta hardware can be identified by its lighter gray pre-production color. Robot Brains, Robot Batteries, Controllers, and Vision Sensors from the V5 beta have a "BETA TEST" stamp on them. Smart Motors and Radios do not have this stamp, but can still be identified by color.
- g. Components from the VEXplorer kit that are not found in modern VEX V5 kits are not permitted. These include (but may not be limited to) electronics, wheels, non-standard gears, and plastic connectors.
- h. Legacy / discontinued products are only permitted if they are explicitly listed in this game manual, or still listed as V5RC or V5RC legal on the [VEX Robotics website](#).

Using VEX apparel, competition support materials, packaging, or other non-*Robot* products on a VEX V5 Robotics Competition *Robot* goes against the spirit of this rule and is not permitted.

**<R8> Certain non-VEX components are allowed.** *Robots* are allowed the following additional "non-VEX" components:

- a. Any material strictly used as a color filter or a color marker for a legal sensor, such as the VEX Light Sensor or the VEX V5 Vision Sensor.
- b. Any non-aerosol-based grease or lubricating compound, when used in extreme moderation on surfaces and locations that do NOT contact the playing field walls, foam field surface, *Scoring Objects*, or other *Robots*. Grease or lubricant applied directly to V5 Smart Motors or Smart Motor cartridges is prohibited.
- c. Anti-static compound, when used in extreme moderation (i.e., such that it does not leave residue on *Field Elements*, *Scoring Objects*, or other *Robots*).
- d. Hot glue when used to secure cable connections.



- e. An unlimited amount of rope/string, no thicker than 1/4" (6.35 mm).
- f. Commercially available items used solely for bundling or wrapping of 2-wire, 3-wire, 4-wire, or V5 Smart Cables, and/or pneumatic tubing are allowed. These items must solely be used for the purposes of cable/tubing protection, organization, or management. This includes but is not limited to electrical tape, cable carrier, cable track, etc. It is up to inspectors to determine whether a component is serving a function beyond protecting and managing cables and tubing.
- g. Non-functional 3D printed license plates, per <R9> and <R10>, are permitted. This includes any supporting structures whose sole purpose is to hold, mount, or display an official license plate.
- h. Rubber bands that are identical in length and thickness to those included in the VEX V5 product line (#32, #64, and 117B).
- i. Pneumatic components with identical SMC manufacturer part numbers to those listed on the VEX website. For more detail regarding legal pneumatic components, see the [Legal VEX Pneumatics Summary document](#).
- j. Zip ties with identical dimensions as those included in the VEX V5 product line.
- k. A Micro SD card installed in the V5 Robot Brain.

See this [REC Library article](#) for more information.

**<R9> Decorations are allowed.** Teams may add non-functional decorations, provided that they do not affect *Robot* performance in any significant way or affect the outcome of the *Match*. These decorations must be in the spirit of the competition. Inspectors will have final say in what is considered "non-functional." Unless otherwise specified below, non-functional decorations are governed by all standard *Robot* rules.

To be considered "non-functional," any guards, decals, or other decorations must be backed by legal materials that provide the same functionality. For example, if a *Robot* has a giant decal that prevents *Scoring Objects* from falling out of the *Robot*, the decal must be backed by VEX material that would also prevent the *Scoring Objects* from falling out. A simple way to check this is to determine if removing the decoration would impact the performance of the *Robot* in any way.

- a. Anodizing and painting of parts is considered a legal nonfunctional decoration.
- b. Small cameras are permitted as non-functional decorations, provided that any transmitting functions or wireless communications are disabled. Unusually large cameras being used as ballast are not permitted.
- c. VEX electronics may not be used as non-functional decorations.
- d. Decorations that visually mimic *Field Elements* or *Scoring Objects*, or that could otherwise interfere with an opponent's Vision Sensor, are considered functional and are not permitted. The Inspector and *Head Referee* will make the final decision on whether a given decoration or mechanism violates this rule.
- e. Internal power sources (e.g., for a small blinking light) are permitted, provided that no other rules are violated and this source only provides power to the non-functional decoration (i.e., does not directly or indirectly influence any functional portions of the *Robot*).

- f. Decorations which provide feedback to the *Robot* (e.g., by influencing legal sensors) would be considered "functional," and are not permitted.
- g. Decorations which provide visual feedback to *Drive Team Members* (e.g., decorative lighting) are permitted, provided that they do not violate any other rules and serve no other function (e.g., structural support).

**<R10> Officially registered Team numbers must be displayed on Robot license plates.** To participate in an official VEX V5 Robotics Competition event, a *Team* must first register on [roboevents.com](https://roboevents.com) and receive a V5RC *Team* number. This *Team* number must be displayed on the *Robot* using license plates. *Teams* may choose to use the official V5RC License Plate Kit, or may create their own.

- a. License plates must be placed on a minimum of two (2) horizontally opposing sides of the *Robot* (i.e., the top of a *Robot* is not considered a "side"), and must remain visible and attached for the entirety of the *Match*.
- b. *Robots* must use plates that match their *Alliance* color for each *Match* (i.e., red *Alliance Robots* must have their red plates on for the *Match*). It must be abundantly clear which color *Alliance* the *Robot* belongs to.
  - i. If both colors of license plates are mounted on a *Robot*, then the incorrect color must be covered, taped over, or otherwise obscured. Since license plates are considered non-functional decorations, this is a legal non-functional use of tape.
- c. License plates are considered non-functional decorations (per <R9>), and must fulfill all relevant *Robot* rules (e.g., they must fit within the 18" cube, cannot functionally change the stability or rigidity of the *Robot*, cause *Entanglement*, etc.).
- d. *Team* numbers must be in white font, and clearly legible.
- e. License plates must be at least 2.48 inches (63 mm) tall and 4.48 inches (114 mm) wide, i.e., at least the height/width dimensions of the plates in the V5RC License Plate Kit.

The intent of this rule is to make it immediately apparent to *Head Referees* which *Alliance* and which *Team* each *Robot* belongs to, at all times. The 'wrong' color doesn't have to be 100% obscured, but being able to "see through" a *Robot* arm to the wrong color license plate on the opposite side of the *Robot* could cause confusion, and would be considered a *Violation* of <R10a>. It will be at the full discretion of the *Head Referee* and inspector at a given event to determine whether a given custom license plate satisfies the criteria listed in <R10>.

*Teams* wishing to utilize custom plates should be prepared for the possibility of this judgment, and ensure that they are prepared to replace any custom parts with official VEX license plates if requested. Not bringing official replacement plates to an event will not be an acceptable reason for overlooking a violation of one or more points in <R10>.

If a *Robot* must be removed from the *Field* based on this rule, <R3ci> applies and the *Team* should not be issued a "no-show."



Figure R10-1: An example of a license plate made from the V5RC License Plate Kit.



Figure R10-2: An example of a legal custom license plate.

**<R11> Let go of Scoring Objects after the Match.** Robots must be designed to permit easy removal of Scoring Objects from any mechanism without requiring the Robot to have power after a Match.

**<R12> Robots have one Brain.** Robots must ONLY use one (1) VEX V5 Robot Brain (276-4810). Any other microcontrollers or processing devices are not allowed, even as non-functional decorations.

This includes microcontrollers that are part of other VEX product lines, such as VEX Cortex, VEX EXP, VEXpro, VEX CTE, VEX RCR, VEX IQ, VEX GO, or VEX Robotics by HEXBUG. This also includes devices that are unrelated to VEX, such as Raspberry Pi or Arduino devices.

**<R13> Motors are limited.** Robots may use any combination of VEX V5 Smart Motors (11W) (276-4840) and EXP Smart Motors (5.5W) (276-4842), within the following criteria:

- The combined power of all motors (11W & 5.5W) must not exceed 88W. This limit applies to all motors on the Robot, even those which are not plugged in.
- V5 Smart Motors, and EXP Smart Motors connected to Smart Ports, are the only motors that may be used with a V5 Robot Brain. The 3-wire ports may not be used to control motors of any kind.

Example	A	B	C	D	E
Qty of 11W Motors	8	7	6	5	0
Qty of 5.5 Motors	0	2	4	6	16

**<R14> Electrical power comes from VEX batteries only.** Robots may use one (1) V5 Robot Battery (276-4811) to power the V5 Robot Brain.

- No other sources of electrical power are permitted, unless used as part of a non-functional decoration per <R9e>.
- There are no legal power expanders for the V5 Robot Battery.
- V5 Robot Batteries may only be charged by a V5 Robot Battery Charger (276-4812 or 276-4841).

- d. V5 Wireless Controllers may only be powered by their internal rechargeable battery.
  - i. *Teams* are permitted to have an external power source (such as a rechargeable battery pack) plugged into their V5 Controller during a *Match*, provided that this power source is connected safely and does not violate any other rules, such as <G10> or <R16>.
  - ii. Some events may choose to provide field power for V5 Wireless Controllers. If this is provided for all *Teams* at the event, then this is a legal power source for the wireless remotes.

**<R15> No modifications to electronic or pneumatic components are allowed.** Motors (including the V5 Smart Motor firmware), microcontrollers (including V5 Robot Brain firmware), cables, sensors, controllers, battery packs, reservoirs, solenoids, pneumatic cylinders, and any other electrical or pneumatics component of the VEX platform may NOT be altered from their original state in ANY way.

- a. External wires on VEX 2-wire or 3-wire electrical components may be repaired by soldering or using twist/crimp connectors, electrical tape, or shrink tubing such that the original functionality and length are not modified in any way.
  - i. Wire used in repairs must be identical to VEX wire.
  - ii. *Teams* make these repairs at their own risk; incorrect wiring may have undesired results.
- b. *Teams* must use VEXos version 1.1.3 or newer, found at <https://link.vex.com/firmware>. Custom firmware modifications are not permitted.
  - i. The minimum version requirement is subject to change over the course of the season.
  - ii. When the minimum version is updated, *Teams* have a two week (14 calendar day) grace period from the time the minimum version is changed to update their firmware to the latest minimum version.
  - iii. VEX reserves the right to deem any firmware update critical, and remove the allowable grace period.
- c. *Teams* may make the following modifications to the V5 / EXP Smart Motor's user-serviceable features. **This list is all-inclusive**; no other modifications are permitted. Where applicable, the components listed below (in the specific applications listed below) are permissible exceptions to <R21> Clauses c.ii.-c.iv. also apply to EXP Smart Motors (5.5W).
  - i. Replacing the gear cartridge with other official cartridges.
  - ii. Removing or replacing the screws from the V5 Smart Motor Cap (276-6780).
  - iii. Removing or replacing the threaded mounting inserts (276-6781).
  - iv. Aesthetic/non-functional labeling (e.g., markers, stickers, paint, etc.).
- d. V5 Smart Motors (11W) **must** use an official VEX V5 gear cartridge. For the purposes of this rule, the gear cartridges found within the V5 Smart Motor are considered "part of the motor." Therefore, any physical or functional modifications to official gear cartridges is not permitted. 11w V5 Smart Motors may only use official VEX motor cartridges.
- e. For the purposes of this rule, the V5 Smart Motor Cap is not considered "part of the motor." Therefore, <R16> applies.

**<R16> Most modifications to non-electrical components are allowed.** Physical modifications, such as bending or cutting, of legal metal structure or plastic components are permitted.

- a. Internal or external mechanical repairs of VEX Limit and Bumper switches are permitted.
  - i. Modifying the metal arm on the Limit Switch is permitted.
  - ii. Using components from these devices in other applications is prohibited.
- b. Metallurgical modifications that change fundamental material properties, such as heat treating or melting, are not permitted.
- c. Pneumatic tubing may be cut to desired lengths.
- d. Fusing/melting the end of legal nylon rope/string (see <R8e>) to prevent fraying is permitted.
- e. Welding, soldering, brazing, gluing, or attaching parts to each other in any way that is not provided within the VEX platform is not permitted. Rule <R8> clause D is an exception to this rule.
- f. Mechanical fasteners may be secured using Loctite or a similar thread-locking product. This may ONLY be used for securing hardware, such as screws and nuts.

**<R17> Robots use VEXnet.** Robots must ONLY utilize the VEXnet system for all wireless *Robot* communication.

- a. Electronics from the Cortex, VEX EXP, VEX CTE, VEXpro, VEX RCR, VEXplorer, VEX IQ, VEX GO, or VEX Robotics by HEXBUG product line are prohibited unless otherwise noted in <R7c> or <R13>.
- b. V5 Controllers may only be used in conjunction with a V5 Robot Brain.
- c. *Teams* are permitted to use the Bluetooth® capabilities of the V5 Robot Brain and/or V5 Controller in *Team* pits, practice fields, and *Robot Skills Matches*. However, VEXnet must be used for wireless communication during head-to-head *Matches*.
- d. *Teams* are permitted to use the Wi-Fi capabilities of the Vision Sensor in *Team* pits or outside of *Matches*. However, the Vision Sensor must have its wireless transmitting functionality disabled during *Matches*.

**<R18> Give the radio some space.** The V5 Radio must be mounted such that no metal surrounds the radio symbol on the V5 Radio.

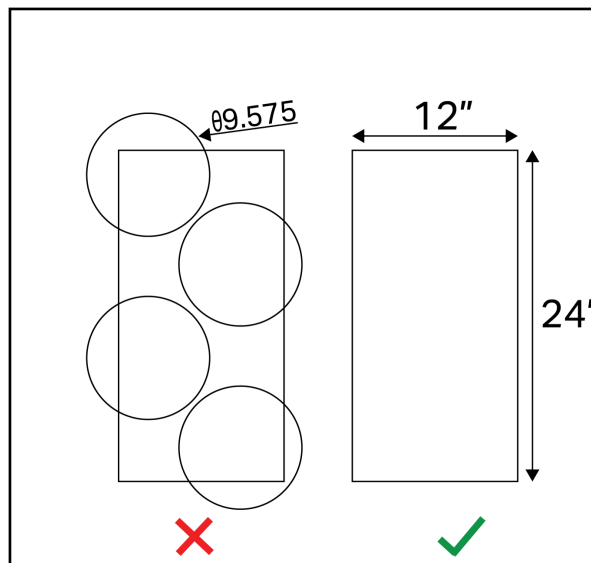
It is fine to loosely encapsulate the V5 Radio within *Robot* structure. The intent of this rule is to minimize radio connection issues by minimizing obstructions between VEXnet devices. Burying a radio deep within a *Robot* may result in *Robot* communication issues.

**<R19> A limited amount of custom plastic is allowed.** Robots may use custom-made parts cut from certain types of non-shattering plastic. It must be possible to have cut all of the plastic parts on the *Robot* from a single 12" x 24" sheet, up to 0.070" thick.

- a. The intent of the area/thickness constraints is to limit the number of custom plastic parts used in *Robot* construction, not to define an absolute volume. For example, using a sheet which is 0.035" thick does not permit two 12" x 24" sheets' worth of parts.
- b. Plastic parts do not have to be literally cut from the same original 12" x 24" sheet. However, all individual parts must be able to "nest" or rearrange into a 12" x 24" area.
  - i. A collection of parts which theoretically have a total surface area of 288 square inches, but cannot be nested onto a single 12" x 24" sheet, would not be legal. See Figure R19-1.
- c. Plastic may be mechanically altered by cutting, drilling, bending, etc. It cannot be chemically treated, melted, or cast. Heating polycarbonate to aid in bending is acceptable.
- d. Legal plastic types include polycarbonate (Lexan), acetal monopolymer (Delrin), acetal copolymer (Acetron GP), POM (acetal), ABS, PEEK, PET, HDPE, LDPE, Nylon (all grades), Polypropylene, and FEP.
- e. Shattering plastic, such as PMMA (also called Plexiglass, Acrylic, or Perspex), is prohibited.
- f. Plastic sheets sold by VEX are considered "plastic" in the context of this rule, and are subject to the same limitations as "off-the-shelf" plastic sheets. Examples include the 276-8340 PET sheets, and the 217-6626 / 217-6627 polycarbonate sheets.
- g. This rule does not apply to 3D printed plastic parts. 3D printed parts are not permitted in the VEX V5 Robotics Competition, except as non-functional decorations (per <R9>) or as custom license plates (per <R10>).

*Note: The phrase "as cut from a single 12" x 24" sheet" is intended to mean that all individual plastic pieces must be able to theoretically "nest" or rearrange into a 12" x 24" area. The plastic pieces do not have to be cut from the same original 12" x 24" sheet. Teams are encouraged to "map" plastic use on a 12" x 24" sheet of paper for reference at tournament inspection.*

**Figure R19-1:** Custom plastic parts must fit within a single 12" x 24" sheet of plastic.



**<R20> A limited amount of tape is allowed.** Robots may use a small amount of tape for the following purposes:

- a. To secure any connection between the ends of two (2) VEX cables.
- b. To label wires and motors.
- c. To cover the backs of license plates (i.e., hiding the “wrong color”).
- d. To prevent leaks on the threaded portions of pneumatic fittings. This is the only acceptable use of Teflon tape.
- e. In any other application that would be considered a “non-functional decoration” per <R9>.
- f. As an aglet at the end of rope/string to prevent fraying.

**<R21> Certain non-VEX fasteners are allowed.** Robots may use the following commercially available hardware:

- a. #4, #6, #8, M3, M3.5, or M4 screws up to 2.5” (63.5 mm) long.
- b. Shoulder screws cannot have a shoulder length over 0.20” or a diameter over 0.176”.
- c. Any commercially available nut, washer, standoff, and/or non-threaded spacer up to 2.5” (63.5 mm) long which fits these screws.

The intent of the rule is to allow *Teams* to purchase their own commodity hardware without introducing additional functionality not found in standard VEX equipment. It is up to inspectors to determine whether the non-VEX hardware has introduced additional functionality or not.

For the purposes of this rule, weight savings is not considered additional functionality.

If a key component of a *Robot’s* design relies upon convincing an inspector that a specialized component is “technically a screw,” it is probably outside of the spirit and intent of this rule. All specific dimensions listed in this rule are intended to be ‘nominal’ references to hardware sizes found within the VEX V5 product line and/or their metric equivalents.

**<R22> New VEX parts are legal.** Additional VEX components released during the competition season on [www.vexrobotics.com](http://www.vexrobotics.com) are considered legal for use unless otherwise noted.

Some “new” components may have certain restrictions placed on them upon their release. These restrictions will be documented in the official Q&A, in a Game Manual Update, or on their respective product web pages.

**<R23> Pneumatics are limited.** A *Robot's* pneumatic subsystem must satisfy the following criteria:

- a. *Teams* may use a maximum of two (2) legal VEX pneumatic air reservoirs on a *Robot*. The Air Tank 200mL (included in the 276-8750 V5 Pneumatics Kit) and the legacy (pre-2023) reservoir are both considered legal reservoirs.
- b. Pneumatic devices may be charged to a maximum of 100 psi.
- c. The compressed air contained inside a pneumatic subsystem can only be used to actuate legal pneumatic devices (e.g., cylinders).

*Note: From a rules perspective, parts found in the V5 Pneumatics Kit (276-8750) and legacy (pre-2023) pneumatic parts may be used interchangeably. [A Legal Pneumatics summary can be found in the VEX Library](#), which includes additional pneumatics information.*

The intent of <R23a> and <R23b> is to limit *Robots* to the air pressure stored in two reservoir tanks, as well as the normal working air pressure contained in their pneumatic cylinders and tubing on the *Robot*. *Teams* may not use other elements for the purposes of storing or generating air pressure.

Using cylinders or additional pneumatic tubing solely for additional storage is in *Violation* of the spirit of this rule. Similarly, using pneumatic cylinders and/or tubing without any air reservoirs is also in *Violation* of the spirit of this rule.

The intent of <R23c> is to ensure that pneumatics are being used safely. Pressurized systems, such as a *Robot's* pneumatic subsystem, have the potential to be dangerous if used incorrectly. This rule ensures the safety of participants, and prevents potentially unsafe uses in the future.

Another way of thinking of <R23c> is that "pneumatics should only be used with pneumatics." *Teams* should not use compressed air as a means of actuating non-pneumatic devices such as screws, nuts, etc. For example, pulling a pin with a pneumatic cylinder is okay, but using air to actuate the pin itself is not.

**<R24> One or two Controllers per Robot.** No more than two (2) VEX V5 Controllers may control a single *Robot*.

- a. No physical or electrical modification of these Controllers is allowed under any circumstances.
  - i. Attachments which assist the *Drive Team Member* in holding or manipulating buttons/joysticks on the V5 Controller are permitted, provided that they do not involve direct physical or electrical modification of the Controller itself.
- b. No other methods of controlling the *Robot* (light, sound, etc.) are permissible.
  - i. Using sensor feedback to augment driver control (such as motor encoders or the Vision Sensor) is permitted.



**<R25> Custom V5 Smart Cables are allowed.** *Teams* who create custom cables acknowledge that incorrect wiring may have undesired results.

- a. Official V5 Smart Cable Stock must be used.
- b. Use of non-VEX 4P4C connectors and 4P4C crimping tools is permissible.
- c. V5 Smart Cables may only be used for connecting legal electronic devices to the V5 Robot Brain.

**<R26> Keep the power button accessible.** The on/off button on the V5 Robot Brain must be accessible without moving or lifting the *Robot*. All screens and/or lights must also be easily visible by competition personnel to assist in diagnosing *Robot* problems.

**<R27> Use a "Competition Template" for programming.** The *Robot* must be programmed to follow control directions provided by the VEXnet Field Controllers or Smart Field Control system. During the *Autonomous Period*, *Drive Team Members* will not be allowed to use their V5 Controllers. As such, *Teams* are responsible for programming their *Robot* with custom software if they want to perform in the *Autonomous Period*. *Robots* must be programmed to follow control directions provided by the field controls (e.g., ignore wireless input during the *Autonomous Period*, *Disable* at the end of the *Driver Controlled Period*, etc.).

*Teams* must use a provided "competition template" or functional equivalent to accomplish this. This will be tested in inspection, where *Robots* will be required to pass a functional "enable/disable" test. For more information on this, *Teams* should consult the help guides produced by the developers of their chosen programming software.

**<R28> There is a difference between accidentally and willfully violating a Robot rule.** Any *violation* of *Robot* rules, accidental or intentional, will result in a *Team* being unable to play until they pass inspection (per <R3d>).

However, *Teams* who intentionally and/or knowingly circumvent or violate rules to gain an advantage over their fellow competitors are in violation of the spirit and ethos of the competition. Any *Violation* of this sort may be considered a violation of <G1> and/or the REC Foundation Code of Conduct.

# Section 4

## The Tournament

### Overview

VEX V5 Robotics Competition *Matches* are played in a Head-to-Head tournament format. Head-to-Head Tournaments consist of *Qualification Matches* and *Elimination Matches*. *Qualification Matches* are used to rank *Teams* based on *Win Points (WP)*, *Autonomous Points (AP)*, and *Strength of Schedule Points (SP)*. The top-ranked *Teams* will then form *Alliances* to participate in *Elimination Matches* and determine the tournament champions. For information about the requirements for tournaments that qualify *Teams* to championship events, [visit this article in the REC Library](#).

This section refers primarily to Head-to-Head *Matches*. For other types of *Matches*, see Sections 5 & 6.

## Tournament Definitions

**Alliance Captain** – One of the *Teams* with the privilege of inviting another available *Team* to form an *Alliance* for the *Elimination Matches*. See <T18>.

**Alliance Selection** – The process of choosing the permanent *Alliances* for the *Elimination Matches*. *Alliance Selection* proceeds as follows:

1. The highest-ranked *Team* at the end of *Qualification Matches* becomes the first *Alliance Captain*.
2. The *Alliance Captain* invites another *Team* to join their *Alliance*.
3. The invited *Team Representative* either accepts or declines as outlined in <T18>.
4. The next-highest-ranked *Team* becomes the next *Alliance Captain*.
5. *Alliance Captains* continue to select their *Alliances* in this order until all *Alliances* are formed for the *Elimination Matches*.

**Autonomous Points (AP)** – The second basis of ranking *Teams*. An *Alliance* who wins the *Autonomous Bonus* during a *Qualification Match* earns six (6) *Autonomous Points*. In the event of a tie, both *Alliances* will receive three (3) *Autonomous Points*.

**Autonomous Win Point** – One (1) *Win Point (WP)* given to an *Alliance* that completes the tasks described in <SC8>, by the end of the *Autonomous Period*. Both *Alliances* can earn this WP if both *Alliances* accomplish this task.

**Bye** – A situation in which an *Alliance* automatically advances to the next round of tournament play without competing.

**Elimination Bracket** – A schedule of *Elimination Matches* for eight (8) to sixteen (16) *Alliances*. See <T19>.

**Elimination Match** – A *Match* used in the process of determining the champion *Alliance*. *Alliances* of two (2) *Teams* face off according to the *Elimination Bracket*; the winning *Alliance* moves on to the next round.

**Event Partner** – The volunteer VEX V5 Robotics Competition tournament coordinator who serves as an overall manager for the volunteers, venue, event materials, and all other event considerations. *Event Partners* serve as the official liaison between the REC Foundation, the event volunteers, and event attendees.

**Head Referee** – A certified impartial volunteer responsible for enforcing the rules in this manual as written. *Head Referees* are the only individuals who may discuss ruling interpretations or scoring questions with *Teams* at an event. Large events (e.g., Signature Events, World Championships, etc.) might include multiple *Head Referees* at the *Event Partner's* discretion.

**Match Schedule** – A list of *Matches* that is generated at the start of an event. The *Match Schedule* includes the predetermined, randomly-paired *Alliances* that will be competing in each *Qualification Match*, and the expected start times for these *Matches*. The *Match Schedule* may be subject to change at the *Event Partner's* discretion.


<b>Qualification Match List</b> <small>KALAHARI CLASSIC INDOOR WATERPARK VEX VRC High School Signature Event - Zambezi</small> 						
Match	Field	Time	Red 1	Red 2	Blue 1	Blue 2
Q1	Field 1	Fri 9:00 AM	3547Y	7316G	248E	99999V
Q2	Field 1	Fri 9:06 AM	3145M	26681B	8823G	23017A
Q3	Field 1	Fri 9:12 AM	59759A	45224A	6008B	2011G
Q4	Field 1	Fri 9:18 AM	75476Z	7882F	11124E	169A
Q5	Field 1	Fri 9:24 AM	7882B	9364C	40938A	1375A
Q6	Field 1	Fri 9:30 AM	7316A	98575A	6210Y	6741A
Q7	Field 1	Fri 9:36 AM	97031A	6008Z	6741E	7316X
Q8	Field 1	Fri 9:42 AM	2894B	5430A	1274A	3547A
Q9	Field 1	Fri 9:48 AM	11254X	60883D	23017C	2719J
Q10	Field 1	Fri 9:54 AM	323V	9364E	2011A	81P
Q11	Field 1	Fri 10:00 AM	6842C	2719A	6302U	248C
Q12	Field 1	Fri 10:06 AM	11124W	6403W	9364A	9257C
Q13	Field 1	Fri 10:12 AM	2011C	6008N	244D	44691X
Q14	Field 1	Fri 10:18 AM	60470S	8823C	8823E	11124P
Q15	Field 1	Fri 10:24 AM	7316E	2011E	38141A	40938C

Figure MS-1: An example of a Qualification Match Schedule

**Practice Match** – A *Match* used to provide time for *Teams* and volunteers to get acquainted with the official playing field and procedures. *Practice Matches* earn *Teams* zero (0) *Win Points*, *Autonomous Points*, and *Strength of Schedule Points*.

**Qualification Match** – A *Match* used to determine *Team* rankings for *Alliance Selection*. Each *Qualification Match* consists of two *Alliances* competing to earn *Win Points*, *Autonomous Points*, and *Strength of Schedule Points*.

**Scorekeeper Referee** – An impartial volunteer responsible for tallying scores at the end of a *Match*. *Scorekeeper Referees* do not make ruling interpretations, and should redirect any *Team* questions regarding rules or scores to a *Head Referee*.

**Strength of Schedule Points (SP)** – The third basis of ranking *Teams*. *Strength of Schedule Points* are equivalent to the score of the losing *Alliance* in a *Qualification Match*. In the event of a tie, both *Alliances* receive SPs equal to the tie score. If both *Teams* on an *Alliance* are *Disqualified*, the *Teams* on the not *Disqualified Alliance* will receive their own score as SPs for that *Match*.

**Time Out** – A single break period no greater than three minutes (3:00) allotted for each *Alliance* during the *Elimination Bracket*. See <T9>.

**Win Points (WP)** – The first basis of ranking *Teams*. *Teams* will receive zero (0), one (1), two (2), or three (3) *Win Points* for each *Qualification Match*. Unless a *Team* is *Disqualified*, both *Teams* on an *Alliance* always earn the same number of WPs.

- One (1) WP is awarded for completing the *Autonomous Win Point* task(s).
- Two (2) WPs are awarded for winning a *Qualification Match*.
- One (1) WP is awarded for tying a *Qualification Match*.
- Zero (0) WPs are awarded for losing a *Qualification Match*.

**Win Percentage (WP)** – Replaces *Win Points* in a league event. *Win Percentage* is calculated by the number of wins divided by the number of *Qualification Matches* the *Team* plays. In cases of a tie, the *Team* is given a 0.5 number of "wins" for that match. The *Autonomous Win Point* is also considered 0.5 "wins," added to the total number of wins.

# Tournament Rules

**<T1> Head Referees have ultimate and final authority on all gameplay ruling decisions during the competition.**

- a. *Scorekeeper Referees* score the *Match*, and may serve as observers or advisers for *Head Referees*, but may not determine any rules or infractions directly.
- b. When issuing a *Major Violation* or *Minor Violation* to a *Team*, *Head Referees* must provide the rule number of the specific rule that has been *Violated*, and record the *Violation* on the Match Anomaly Log.
- c. *Violations* of the REC Foundation Code of Conduct may involve additional escalation beyond a *Head Referee's* initial ruling, including (but not limited to) investigation by an REC Foundation representative. Rules <S1>, <G1>, <G2> and <G4> are the only rules for which this escalation may be required.
- d. *Event Partners* may not overrule a *Head Referee's* decision.
- e. Every *Qualification Match* and *Elimination Match* must be watched by a certified *Head Referee*. *Head Referees* may only watch one *Match* at a time; if multiple *Matches* are happening simultaneously on separate fields, each field must have its own *Head Referee*.

Note from the VEX GDC: The rules contained in this Game Manual are written to be enforced by human *Head Referees*. Many rules have "black-and-white" criteria that can be easily checked. However, some rulings will rely on a judgment call from this human *Head Referee*. In these cases, *Head Referees* will make their calls based on what they and the *Scorekeeper Referees* saw, what guidance is provided by their official support materials (the Game Manual and the Q&A), and most crucially, the context of the *Match* in question.

The VEX V5 Robotics Competition does not have video replay, our fields do not have absolute sensors to count scores, and most events do not have the resources for an extensive review conference between each *Match*.

When an ambiguous rule results in a controversial call, there is a natural instinct to wonder what the "right" ruling "should have been," or what the GDC "would have ruled." This is ultimately an irrelevant question; our answer is that when a rule specifies "*Head Referee's* discretion" (or similar), then the "right" call is the one made by a *Head Referee* in the moment. The VEX GDC designs games, and writes rules, with this expectation (constraint) in mind.

**<T2> Head Referees must be qualified.** V5RC *Head Referees* must have the following qualifications:

- a. Be at least 20 years of age.
- b. Be approved by the *Event Partner*.
- c. Be an REC Foundation Certified V5RC *Head Referee* for the current season. [Visit this KB article](#) for more details.

*Note: Scorekeeper Referees must be at least 15 years of age, and must be approved by the Event Partner.*

*Head Referees should demonstrate the following attributes:*

- Thorough knowledge of the current game and rules of play
- Effective decision-making skills
- Attention to detail
- Ability to work effectively as a member of a team
- Ability to be confident and assertive when necessary
- Strong communication and diplomacy skills

**<T3> The Drive Team is permitted to immediately appeal a Head Referee's ruling.** If *Drive Team Members* wish to dispute a score or ruling, they must stay in the *Alliance Station* until the *Head Referee* from the *Match* talks with them. The *Head Referee* may choose to meet with the *Drive Team Members* at another location and/or at a later time so that the *Head Referee* has time to reference materials or resources to help with the decision. Once the *Head Referee* announces that their decision has been made final, the issue is over and no more appeals may be made (See rule <T1>).

- a. *Head Referees* may not review any photo or video *Match* recordings when determining a score or ruling.
- b. *Head Referees* are the only individuals permitted to explain a rule, *Disqualification*, *Violation*, warning, or other penalty to the *Teams*. *Teams* should never consult other field personnel, including *Scorekeeper Referees*, regarding a ruling clarification.

Communication and conflict resolution skills are an important life skill for *Students* to practice and learn. In VEX V5 Robotics Competitions, we expect *Students* to practice proper conflict resolution using the proper chain of command. *Violations* of this rule may be considered a *Violation* of <G1> and/or the Code of Conduct.

Some events may choose to utilize a "question box" or other designated location for discussions with *Head Referees*. Offering a "question box" is within the discretion of the *Event Partner* and/or *Head Referee*, and may act as an alternate option for asking *Drive Team Members* to remain in the *Alliance Station* (although all other aspects of this rule apply).

However, by using this alternate location, *Drive Team Members* acknowledge that they are forfeiting the opportunity to use any contextual information involving the specific state of the *Field* at the end of the *Match*. For example, it is impossible to appeal whether a game element was *Scored* or not if the *Field* has already been reset. If this information is pertinent to the appeal, *Drive Team Members* should still remain in the *Alliance Station*, and relocate to the "question box" once the *Head Referee* has been made aware of the concern and/or any relevant context.

**<T4> The Event Partner has ultimate authority regarding all non-gameplay decisions during an event.** The Game Manual is intended to provide a set of rules for successfully playing V5RC High Stakes; it is not intended to be an exhaustive compilation of guidelines for running a VEX V5 Robotics Competition event. Rules such as, but not limited to, the following examples are at the discretion of the *Event Partner* and should be treated with the same respect as the Game Manual.

- Venue access
- Pit spaces
- Health and safety
- *Team* registration and/or competition eligibility
- *Team* conduct away from competition fields

This rule exists alongside <G1>, <S1>, and <G3>. Even though there isn't a rule that says "do not steal from the concession stand," it would still be within an *Event Partner's* authority to remove a thief from the competition.

**<T5> A Team's Robot and/or Drive Team Member should attend every Match.** A *Robot* or a *Student* member of the *Team* must report to the field for the *Team's* assigned *Match*, even if the *Robot* is not functional. If no *Student Drive Team Members* report to the *Field*, the *Team* will be considered a "no-show" and receive zero (0) *WPs*, *AWPs*, *APs*, and *SPs*.

**<T6> Robots at the field must be ready to play.** If a *Team* brings their *Robot* to the *Field*, it must be prepared to play (e.g., batteries charged, sized within the starting size constraint, displaying only the correct *Alliance-color* license plates, etc.).

- a. *Teams* who use VEX pneumatics must have their systems charged before they place the *Robot* on the *Field*.
- b. *Robots* must be placed on the *Field* promptly. Repeated failure to do so could result in a *Violation* of <G1>. The exact definition of the term "promptly" is at the discretion of the *Head Referee* and *Event Partner*, who will consider event schedule, previous warnings or delays, etc.
- c. If a *Robot* is delaying the scheduled start of a *Match*, it may be removed from the *Field* at the discretion of the *Head Referee* and *Event Partner*. A *Drive Team Member* may remain at the *Field* so that the *Team* does not get assessed a "no-show" (per <T5>).

**<T7> Match replays are allowed, but rare.** *Match* replays (i.e., playing a *Match* over again from its start) must be agreed upon by both the *Event Partner* and *Head Referee*, and will only be issued in the most extreme circumstances. Some example situations that may warrant a *Match* replay are as follows:

- a. *Match Affecting* "field fault" issues.
  - i. *Scoring Objects* not starting in the correct positions.
  - ii. Tape lines lifting.
  - iii. *Field Elements* detaching or moving beyond normal tolerances (not as a result of *Robot* interactions).
  - iv. The *Autonomous Period* or *Driver Controlled Period* ending early.
  - v. *Field* control disconnecting or disabling *Robots*. Note, this is sometimes confused with a *Robot* whose motors have overheated, or bent pins on a controller's competition port causing intermittent drop-outs. In general, any true field fault will impact both *Alliances* simultaneously, not one *Robot* at a time.
- b. *Match Affecting* game rule issues.
  - i. *Head Referee Disables* a *Robot* for a misinterpretation of a rule *Violation*.
  - ii. *Head Referee* starts the *Driver Controlled Period* of the *Match* without determining the outcome of the *Autonomous Period* winner.
  - iii. The *Field* is reset before a score is determined.

Note: As of the 2024-2025 season, the V5 white screen error is no longer a permitted cause for a replay. [More information about this error can be found here.](#)

**<T8> Disqualifications.** When a *Team* receives a *Disqualification* in a *Qualification Match*, they receive a score of zero (0) for the *Match*, as well as zero (0) *Win Points*, *Autonomous Win Points*, *Autonomous Points*, and *Strength of Schedule Points*.

- a. If the *Team* receiving the *Disqualification* is on the winning *Alliance*, then *Teams* on the opposing *Alliance* who are not also *Disqualified* will receive the win for the *Match* and two (2) *WP*.
  - i. The *Team's* non-*Disqualified Alliance* Partner is unaffected, i.e. they will receive the win for the *Match* and two (2) *WP*.
- b. If the *Match* was a tie, then each *Team* on the opposing *Alliance* (the *Alliance* that did not receive the *Disqualification*) will receive the win for the *Match* and two (2) *WP*. If both *Alliances* have a *Team* receiving a *Disqualification*, then all non-*Disqualified Teams* will receive a tie for the *Match* and one (1) *WP*.
- c. *Autonomous Win Points* are not given to *Teams* that receive a *Disqualification*, and are not automatically awarded to the opposing *Alliance*.

When a *Team* is *Disqualified* in an *Elimination Match*, the entire *Alliance* is *Disqualified*; they receive a loss for the *Match*, and the opposing *Alliance* is awarded the win. If both *Alliances* receive a *Disqualification* in an *Elimination Match*, both *Alliances* receive a loss and will play another *Match* to determine a winner.

Note: If a *Team* is *Disqualified* in a *Robot Skills Match*, a score of zero (0) will be recorded for that *Match*.



**<T9> Each Elimination Alliance gets one Time Out.** Each Elimination *Alliance* gets one *Time Out*. Each *Alliance* may request one (1) *Time Out* during the *Elimination Bracket*. The *Time Out* will be served at the time of the *Alliance's* next upcoming *Match*. *Alliances* must request their *Time Out* between *Elimination Matches*, as permitted by the *Head Referee* and *Event Partner*; they may not use their *Time Out* during a *Match*, for another *Alliance's Match*, or after they have been eliminated.

**<T10> Be prepared for minor field variance.** *Field Element* tolerances and *Scoring Objects* may vary from specified locations/dimensions; *Teams* are encouraged to design their *Robot* accordingly. Please make sure to check Appendix A for more specific nominal dimensions and tolerances.

- a. *Field Element* tolerances may vary from nominal by up to  $\pm 1.0$ ".
- b. *Rings* and *Mobile Goal* placement at the beginning of the *Match* may vary from nominal by up to  $\pm 1$ " (25.4 mm).
- c. *Ladder* rung heights may vary from nominal by up to  $\pm 1$ " (25.4 mm).
- d. *Rings* have a nominal weight of .25lbs and may vary by +/- .075lbs (113.4g +/- 34g).
- e. *Mobile Goals* have a nominal weight of 2lbs and may vary by +/- .075lbs (907g +/- 34g).
- f. *Wall Stake* height and *Mobile Goal* heights may vary from nominal by up to  $\pm 1$ " (25.4 mm).
- g. The rotation of *Mobile Goals* is not specified

**<T11> Fields may be repaired at the Event Partner's discretion.** All competition fields at an event must be set up in accordance with the specifications in Appendix A and/or other applicable Sections. Minor aesthetic customizations or repairs are permitted, provided that they do not impact gameplay (see <T4>).

Examples of permissible modifications include, but are not limited to:

- Applying threadlocker to *Field Element* mounting hardware
- Using non-VEX white electrical tape to add required lines to the *Field*
- Using standard 1/2" Schedule 40 PVC pipe to replace a damaged *Wall Stake*

Examples of prohibited modifications include, but are not limited to:

- Unofficial *Field Perimeter* walls, additional structural elements inside of the *Field Perimeter*, or unofficial/replica *Field Elements*
- Additional VEX structural parts attached to a *Field Element*
- Replacing the opaque field walls on the VEX Portable Competition *Field Perimeter* with transparent panels
- Using PVC pipe of a different size or thickness to replace a damaged section of the *Ladder*, *Mobile Goal*, or *Wall Stake*

Any specific repairs and/or modifications which pertain to the current season's game will be documented in this rule and Appendix A, as needed.

Significant Q&As:

- [2009](#) - EPs should not put dots on the field to mark object placement

**<T12> The red Alliance places last.** The red *Alliance* has the right to place its *Robots* on the *Field* last in both *Qualification Matches* and *Elimination Matches*. Once a *Team* has placed its *Robot* on the *Field*, its position cannot be readjusted prior to the *Match*. If a *Team* chooses to reposition their *Robot* after it has already been placed, the opposing *Alliance* will also be given the opportunity to reposition their *Robots* promptly.

**<T13> Qualification Matches follow the Match schedule.** A *Qualification Match Schedule* will be available on the day of competition. The *Match Schedule* will indicate *Alliance* partners, *Match* pairings, and *Alliance* colors for each *Match*. For tournaments with multiple fields, the schedule will indicate which *Field* each *Match* will take place on. The *Match Schedule* is subject to change at the *Event Partner's* discretion. Any multi-division event must be approved by the REC Foundation RSM prior to the event, and divisions must be assigned in sequential order by *Team* number.

**<T14> Each Team will have at least six Qualification Matches.**

- When in a tournament, the tournament must have a minimum of six (6) *Qualification Matches* per *Team* for a standard tournament or eight (8) *Qualification Matches* per championship event. The suggested amount of *Qualification Matches* per *Team* for a standard tournament is eight (8) and up to ten (10) for a championship event.
- When in a league, there must be at least three (3) league ranking sessions, with at least one (1) week between sessions. Each session must have a minimum of two (2) *Qualification Matches* per *Team*. The suggested amount of *Qualification Matches* per *Team* for a standard league ranking session is four (4). Leagues will have a championship session where elimination rounds will be played. *Event Partners* may choose to have *Qualification Matches* as part of their championship session.

**<T15> Qualification Matches contribute to a Team's ranking for Alliance Selection.**

- When in a tournament, every *Team* will be ranked based on the same number of *Qualification Matches*.
- When in a league, every *Team* will be ranked based on the number of *Matches* played. *Teams* that participate at least 60% of the total *Matches* available will be ranked above *Teams* that participate in less than 60% of the total *Matches* available; e.g., if the league offers 3 ranking sessions with 4 *Qualification Matches* per *Team*, *Teams* that participate in 8 or more *Matches* will be ranked higher than *Teams* who participate in 7 or fewer *Matches*. Being a no-show to a *Match* that a *Team* is scheduled in still constitutes participation for these calculations.
- In some cases, a *Team* will be asked to play an additional *Qualification Match*. The extra *Match* will be identified on the *Match Schedule* with an asterisk; *WPs*, *APs*, and *SPs* for that *Qualification Match* will not impact a *Team's* ranking, and will not affect participation percentage for leagues.
  - Teams* are reminded that <G1> is always in effect and *Teams* are expected to behave as if the additional *Qualification Match* counted.

- ii. In Leagues, *Teams* may have a different number of *Qualification Matches*. Rankings are determined by the *Win Percentage*, which is the number of wins divided by the number of *Qualification Matches* that *Teams* have played.

**<T16> Qualification Match tiebreakers.** *Team* rankings are determined throughout *Qualification Matches* as follows:

- a. Average *Win Points* (WP / Number of *Matches* played)
- b. Average *Autonomous Points* (AP / Number of *Matches* played)
- c. Average *Strength of Schedule Points* (SP / Number of *Matches* played)
- d. Highest *Match* score
- e. Second highest *Match* score
- f. Random electronic draw

**<T17> Send a Student representative to Alliance Selection.** Each *Team* must send one (1) *Student* representative to the playing field (or other designated area) to participate in *Alliance Selection*. If the *Team* Representative fails to report in for *Alliance Selection*, their *Team* will be ineligible for participation in the *Alliance Selection* process.

**<T18> Each Team may only be invited once to join one Alliance.** If a *Team* representative declines an *Alliance Captain's* invitation during *Alliance Selection*, that *Team* is no longer eligible to be selected by another *Alliance Captain*. However, they are still eligible to play *Elimination Matches* as an *Alliance Captain*.

For example:

- *Alliance Captain* 1 invites *Team ABC* to join their *Alliance*.
- *Team ABC* declines the invitation.
- No other *Alliance Captains* may invite *Team ABC* to join their *Alliance*.
- However, *Team ABC* may still form their own *Alliance*, if *Team ABC* ranked high enough after *Qualification Matches* to become an *Alliance Captain*.

*Note: Alliances must have two Teams, and there are no "do-overs" during Alliance Selection. If enough Teams decline their invitations such that the full number of Alliances cannot be filled, the event will proceed with a reduced number of Alliances.*

<T19> **Elimination Matches follow the Elimination Bracket.** A sixteen (16) *Alliance* bracket plays as shown in Figure T19-1:

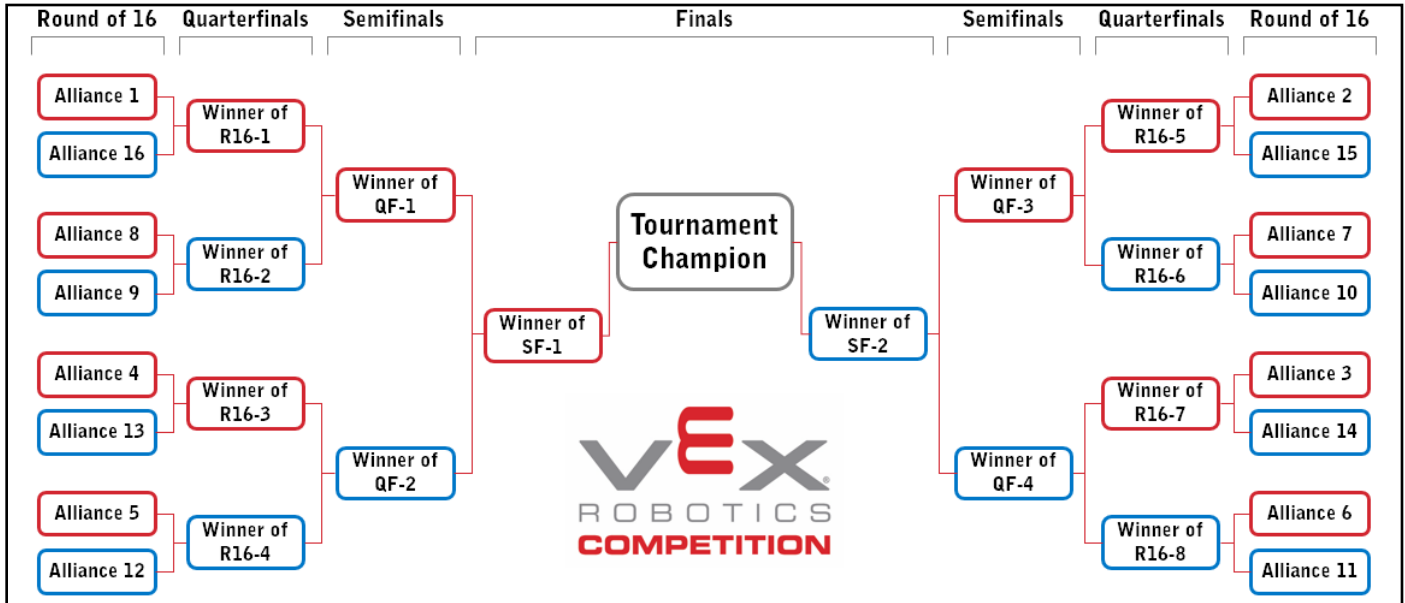


Figure T19-1: A 16-Alliance bracket

If an event is run with fewer than sixteen (16) *Alliances*, then they will use the bracket shown above, with *Byes* awarded when there is no applicable *Alliance*. For example, in a tournament with twelve (12) *Alliances*, *Alliances* 1, 2, 3, & 4 would automatically advance to the Quarterfinals.

Thus, an eight (8) *Alliance* bracket would run as shown in Figure T19-2:

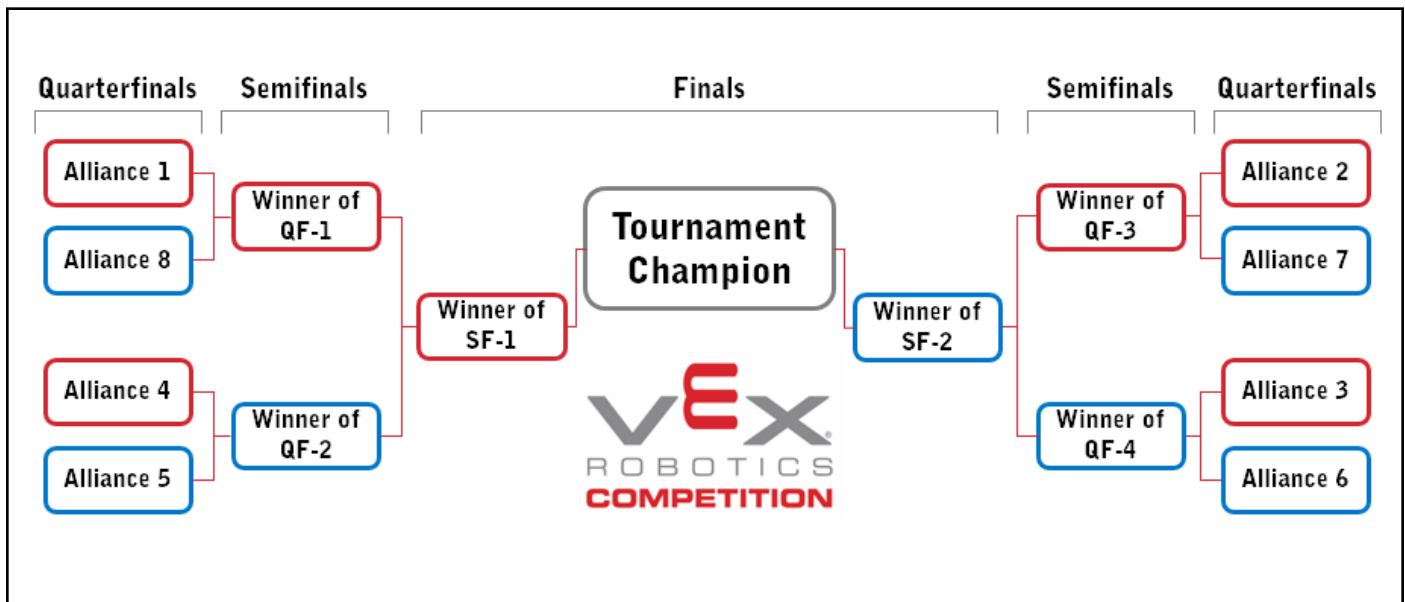


Figure T19-2: An 8-Alliance bracket

<T20> **Elimination Matches are a blend of "Best of 1" and "Best of 3."** "Best of 1" means that the winning *Alliance* in each *Match* advances to the next round of the *Elimination Bracket*. "Best of 3" means that the first *Alliance* to reach two wins will advance.

See the Flowchart in Figure T20-1 for more information.

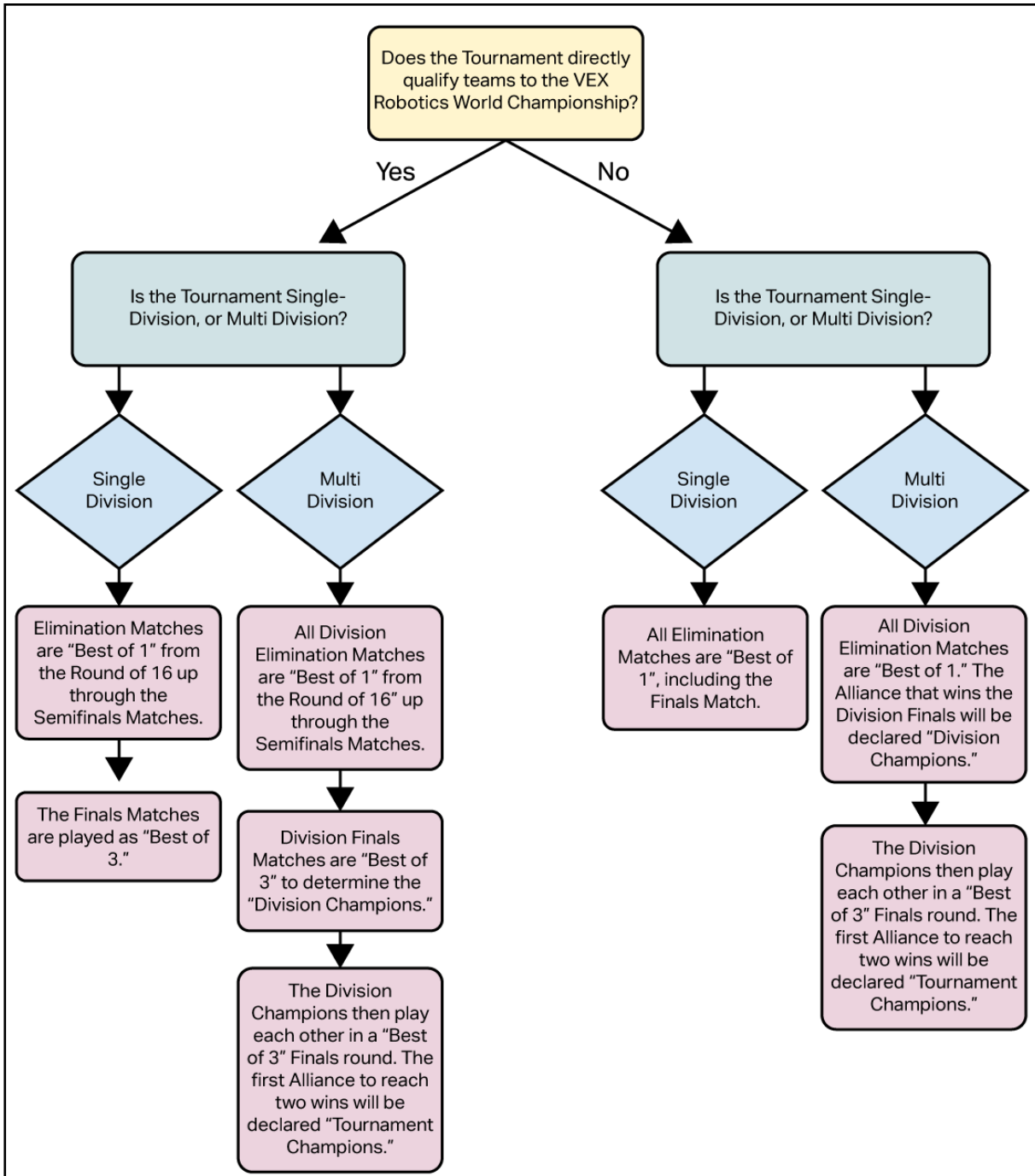


Figure T20-1: The process for determining how Elimination Matches should be played.

**<T21> Small tournaments may have fewer Alliances.** The number of *Alliances* for a given event is determined as follows:

# of Teams	# of Elimination Alliances
32+	16
24-31	12
16-23	8
<16	# of Teams divided by 2, less any remainder

**<T22> Fields at an event must be consistent with each other.** There are many types of permissible aesthetic and/or logistical modifications that may be made to competition fields at the *Event Partner's* discretion. If an event has multiple Head-to-Head competition *Fields*, they must all incorporate the same permissible/applicable modifications. For example, if one field is elevated, then all Head-to-Head competition *Fields* must be elevated to the same height.

Examples of these modifications may include, but are not limited to:

- Elevating the playing *Field* off of the *Floor* (common heights are 12" to 24" [30.5cm to 61cm])
- *Field* control systems (see <T23>)
- *Field* display monitors
- *Field Perimeter* decorations (e.g., LED lights, sponsor decals on polycarbonate panels)
- *Field Perimeter* type (see <T24>)
- Utilizing the VEX GPS Field Code Strips

*Note: If an event has dedicated fields for Skills Challenge Matches, there is no requirement for them to have the same consistent modifications as the Head-to-Head Fields. See <RSC8> for more details.*

**<T23> There are three types of field control that may be used:**

1. A VEXnet Field Controller controlled by Tournament Manager, which connects to a Controller's competition port via ethernet cable.
2. A V5 Event Brain controlled by Tournament Manager, which connects to a Controller via Smart Cable.
3. A VEXnet Competition Switch, which connects to a Controller's competition port via Cat-5 cable, may only be used in *Practice Matches* or *Robot Skills Matches*, and only under extreme circumstances.

If an event has multiple *Fields*, then all *Fields* of the same game type must use the same control system, in accordance with <T23> and <RSC8>. For example, it would be permissible for Head-to-Head competition *Fields* to use V5 Event Brains, and for Skills Challenge *Fields* to use VEXnet Field Controllers. However, it would not be permissible for one Head-to-Head *Field* to use a V5 Event Brain while another Head-to-Head *Field* uses a VEXnet Field Controller.

*Note: Official Qualifying Events may only use the official, unmodified version of Tournament Manager for field control, along with approved hardware and networking solutions found in the REC Library.*

*Note 2: Add-ons that abide by the [TM Public API guidelines](#) are permitted. Once add-ons are enabled, the software is no longer supported by the REC Foundation, VEX Robotics, or DWAB Technologies; any necessary troubleshooting will be done at the user's own risk.*

### <T24> **There are two types of Field Perimeter that may be used:**

1. VEX Metal Competition Field Perimeter (SKU 278-1501)
2. VEX Portable Competition Field Perimeter (SKU 276-8242)

See Appendix A for more details.

If an event has multiple *Fields*, then all fields of the same game type must use the same *Field Perimeter* type, in accordance with <T22> and <RSC8>. For example, it would be permissible for Head-to-Head competition *Fields* to use metal *Field Perimeters*, and for Skills Challenge *Fields* to use Portable Field Perimeters. However, it would not be permissible for one Head-to-Head field to use a metal Field Perimeter, while other Head-to-Head fields use Portable Field Perimeters.

*Note: See <RSC8> for more details specific to Skills Challenge fields.*

# Section 5 - Robot Skills

## Overview

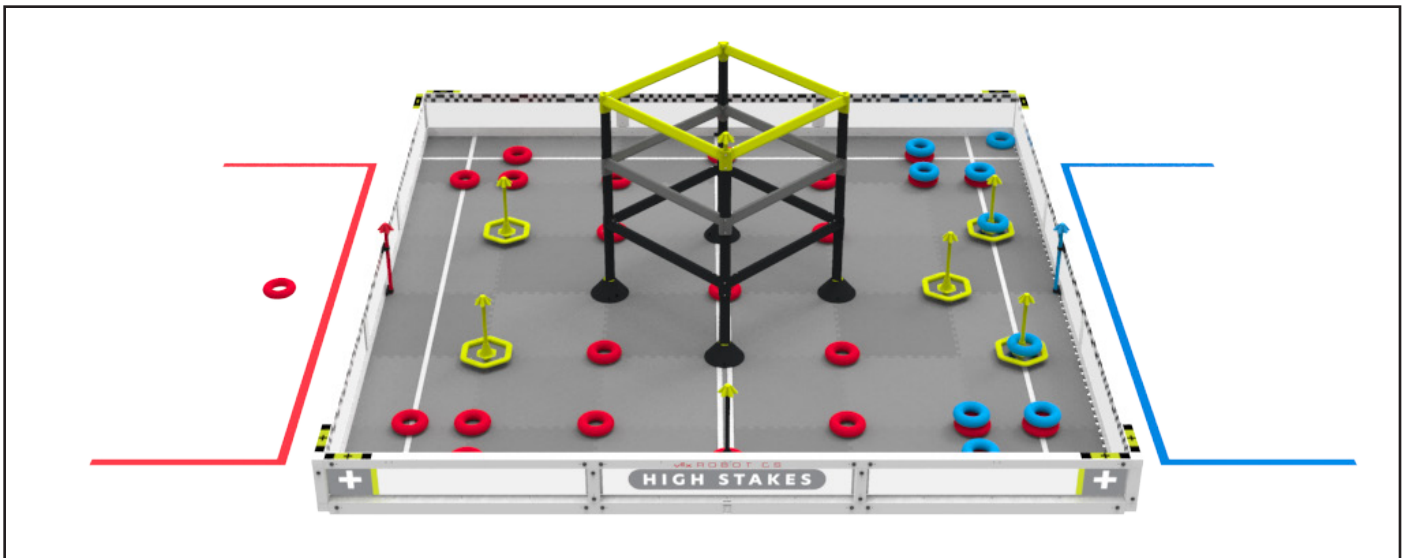
This section describes the Robot Skills Challenge rules for VEX V5 Robotics Competition High Stakes. All rules from “The Game” section of the manual apply to the Robot Skills Challenge, unless otherwise specified in this section.

## Robot Skills Challenge Description

In this challenge, *Teams* will compete in sixty-second (1:00) long *Matches* in an effort to score as many points as possible. These *Matches* consist of *Driving Skills Matches*, which are entirely driver controlled, and *Autonomous Coding Skills Matches*, which are autonomous with limited human interaction. *Teams* will be ranked based on their combined score in the two types of *Matches*.

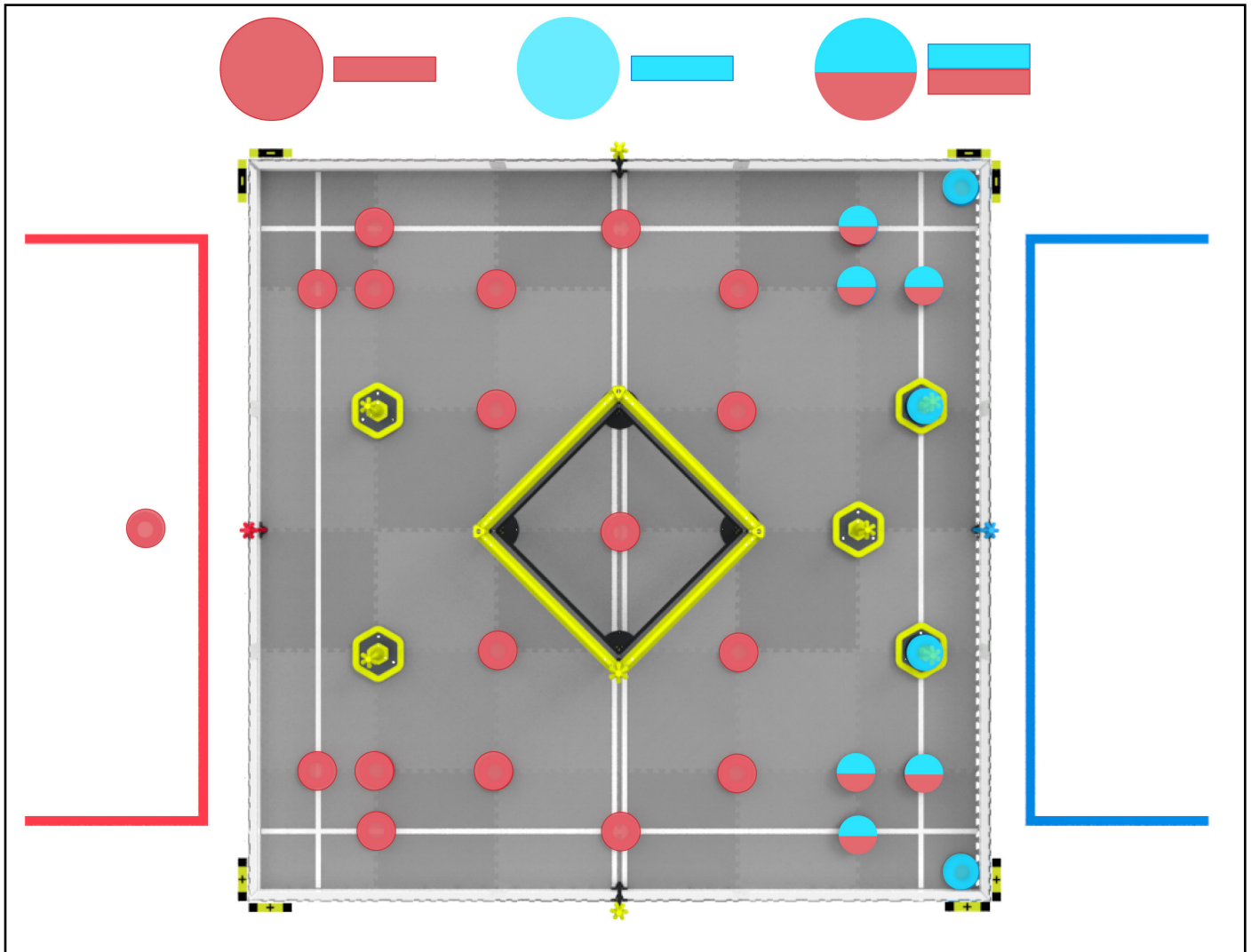
The Robot Skills Challenge playing field layout differs from the layout for Head-to-Head VEX V5 Robotics Competition High Stakes *Matches*, with the following modifications:

- In *Autonomous Coding Skills Matches*, the VEX GPS code strip must be installed on the *Field*
- All 24 red *Rings* and all 5 *Mobile Goals* are used, but some start in different locations
- Not all 24 blue *Rings* are used





The image below is a Top view of the Field in its starting configuration for a *Robot Skills Match*, with highlighted Rings (Red / Blue).



## Robot Skills Challenge Definitions

All definitions from "The Game" section of the manual apply to the Robot Skills Challenge, unless otherwise specified.

**Driving Skills Match** – A *Driving Skills Match* consists of a sixty-second (1:00) *Driver Controlled Period*. There is no *Autonomous Period*. Teams can elect to end their run early if they wish to record a *Skills Stop Time*.

**Autonomous Coding Skills Match** – An *Autonomous Coding Skills Match* consists of a sixty-second (1:00) *Autonomous Period*. There is no *Driver Controlled Period*. Teams can elect to end their run early if they wish to record a *Skills Stop Time*.

**Robot Skills Match** – A *Driving Skills Match* or *Autonomous Coding Skills Match*.

**Skills Stop Time** – The time remaining in a *Robot Skills Match* when a *Team* ends the *Match* early.

- If a *Team* does not end the *Match* early, they receive a default *Skills Stop Time* of 0.
- The moment when the *Match* ends early is defined as the moment when the *Robot* is “*Disabled*” by the field control system. See the “*Skills Stop Time*” section for more details.
- If a V5 Robot Brain or Tournament Manager display is being used for *Field* control, then the *Skills Stop Time* is the time shown on the display when the *Match* is ended early (i.e. in 1-second increments).
- If a VEXnet Competition Switch is being used for *Field* control, in conjunction with a manual timer that counts down to 0 with greater accuracy than 1-second increments, then the time shown on the timer should be rounded up to the nearest second. For example, if the *Robot* is *Disabled* and the timer shows 25.2 seconds, then the *Skills Stop Time* should be recorded as 26.

## Robot Skills Challenge Rules

**<RSC1>** All rules from “The Game” section of the manual apply to the Robot Skills Challenge, unless otherwise specified in this section.

*Violation Note: In the Robot Skills Challenge, the standard definition of Match Affecting does not apply, since there is no winner and loser. When evaluating whether a rule Violation should be classified as a Major Violation or Minor Violation in the context of this criteria, the term “score affecting” can be substituted for “Match Affecting”. A Violation is considered “score affecting” if it resulted in a net increase of that Team’s score at the end of the Match.*

**<RSC2>** *Teams* may play *Robot Skills Matches* on a first-come, first-served basis, or by a pre-scheduled method determined by the *Event Partner*. Each *Team* will get the opportunity to play up to three (3) *Driving Skills Matches* and three (3) *Autonomous Coding Skills Matches*.

*Teams* should review the event agenda and their *Match Schedule* to determine when the best possible time is to complete their *Robot Skills Matches*. If the Robot Skills Challenge area closes before a *Team* has completed all six (6) *Robot Skills Matches*, but it is determined that there was adequate time given, then the *Team* will automatically forfeit those unused *Matches*.

Further details regarding Skills-Only Event logistics can be found in the [REC Foundation Qualifying Criteria document](#).

**<RSC3>** *Robots* must start the *Robot Skills Match* in a legal starting position for the red *Alliance*.

- All *Drive Team Members* must remain in the red *Alliance Station* for the duration of the *Match*.
- Robots* must meet all of the criteria listed in rule <SG1>.

- c. *Teams* may use one (1) red *Alliance* preload as described in rule <SG5>.
- d. The two (2) blue *Alliance* preload *Rings* are not used in *Robot Skills Matches*.
- e. Rule <SG10> does not apply, and *Teams* may freely use the blue *Alliance* wall *Stake*.
- f. Rule <SG11> does not apply.

**<RSC4>** Blue *Rings* may only be *Scored* as *Top Rings* on *Stakes*. Each Blue *Ring* only has a point value if:

- a. All red *Rings* in the *Match* have been *Scored* on *Stakes* and have point values.
- b. At least one red *Ring* is *Scored* below the blue *Ring* on that *Stake*.
- c. There is only one blue *Ring* on that *Stake*.
- d. No red *Rings* are *Scored* above the blue *Ring* on that *Stake*.
- e. Red *Rings* may also be *Scored* as *Top Rings* on *Stakes*, but rule <RSC5> applies.

**<RSC5>** Any red *Ring* *Scored* above a blue *Ring* on the same *Stake* will not have a point value.

**<RSC6>** If any *Ring* is *Scored* on a *Stake* but does not have a point value based on rule <RSC4> or <RSC5>, no *Ring* on that *Stake* will earn points as a *Top Ring*.

**<RSC7>** No *Corner* Modifiers.

- a. There are no *Positive Corners* or *Negative Corners* in *Robot Skills Matches*.
- b. Each *Mobile Goal Placed* in a *Corner* will receive 5 points. Rule <SC5> and its note still apply, and only one *Mobile Goal* may be *Placed* in each *Corner*.

**<RSC8>** There is no requirement that *Skills Challenge Fields* have the same consistent modifications as the *Head-to-Head Fields*. For example, there is no requirement that all *Skills Challenge Fields* are elevated to the same height as *Head-to-Head Fields*. However, all *Skills Challenge Fields* at a single event must use the same type of field control and *Field Perimeter*, as described in rules <T23> and <T24>.

It is strongly recommended/preferred that all *Skills Challenge Fields* are consistent with each other, but this may not be the case in extreme circumstances.

In order to use non-conforming *Head-to-Head Fields* for *Skills Challenge* runs (e.g., during lunch), the following steps should be taken:

- *Teams* must be informed that the *Head-to-Head Fields* may have some differences from the *Skills Challenge Fields* (e.g., they might not have GPS strips).
- *Teams* must be given an opportunity to select which type of *Field* they want to use, i.e. they cannot be required to use the *Head-to-Head Field* for any *Skills Challenge* run.

# Robot Skills Challenge Scoring

Each Ring Scored on a Stake	1 Point*
Each Top Ring on a Stake	3 Points*
Climb - Level 1	3 Points
Climb - Level 2	6 Points
Climb - Level 3	12 Points
Mobile Goal Placed in a Corner	5 Points

*\*Note: Blue Rings only count for points if all red Rings are Scored on Stakes, and blue Rings are only eligible for use as Top Rings that are Scored on top of red Rings. See rules <RSC4>, <RSC5>, and <RSC6> for additional information.*

## Skills Stop Time

If a *Team* wishes to end their *Robot Skills Match* early, they may elect to record a *Skills Stop Time*. This is used as a tiebreaker for Robot Skills Challenge rankings. A *Skills Stop Time* does not affect a *Team's* score for a given *Robot Skills Match*.

- *Teams* who intend to attempt a *Skills Stop Time* must "opt-in" by verbally confirming with the *Scorekeeper Referee* prior to the *Robot Skills Match*. If no notification is given prior to the start of the *Match*, then the *Team* forfeits their option to record a *Skills Stop Time* for that *Match*.
  - This conversation should include informing the *Scorekeeper Referee* which *Drive Team Member* will signal the stop. The *Match* may only be ended early by a *Drive Team Member* for that *Match*.
  - If a *Team* runs multiple *Robot Skills Matches* in a row, they must reconfirm their *Skills Stop Time* choice with the *Scorekeeper Referee* prior to each *Match*.
  - Any questions regarding a *Skills Stop Time* should be reviewed and settled immediately following the *Match*. <T1> and <T3> apply to *Robot Skills Matches*.
- If the event is utilizing a V5 Robot Brain or the TM Mobile app for Robot Skills Challenge *Field* control, a *Drive Team Member* may elect to start and stop their own *Robot Skills Matches*.
  - This V5 Robot Brain or other device running the TM Mobile app will be used to start the *Robot Skills Matches* (i.e., "enable" the *Robot*), end the *Robot Skills Match* (i.e., "Disable" the *Robot*), and display the official *Skills Stop Time* to be recorded.
  - This V5 Robot Brain must be running the official field control user program.
  - For more information regarding the use of a V5 Robot Brain for Robot Skills Challenge *Field* control, and to download the official field control user program, [visit this VEX Knowledge Base article](#).
  - For more information regarding the use of TM Mobile for field control, [see the Tournament Manager documentation](#).

- At events which do not have a V5 Robot Brain or the TM Mobile App available for Robot Skills Challenge *Field* control, *Drive Team Members* and field staff must agree prior to the *Match* on the signal that will be used to end the *Match* early.
  - As noted in the definition of *Skills Stop Time*, the moment when the *Match* ends early is defined as the moment when the *Robot* is "Disabled" by the field control system.
  - The agreed-upon signal must be both verbal and visual, such as *Drive Team Members* crossing their arms in an "X" or placing their V5 Controller(s) on the ground.
  - The signal must be given by a *Drive Team Member* who is standing in the *Alliance Station*.
  - It is recommended that *Drive Team Members* also provide verbal notice that they are approaching their *Skills Stop Time*, such as by counting out "3-2-1-stop."
- It is at the *Event Partner's* discretion which method will be used to record *Skills Stop Times* at a given event. The chosen method must be communicated prior to the event (such as during the event meeting), and made equally available to all *Teams*.
  - If an event intends to use a manual timekeeping method, a *Team* may not bring their own V5 Robot Brain just for use during their own *Robot Skills Match*.
  - If an event intends to utilize a V5 Robot Brain, all *Teams* must use the same V5 Robot Brain for all *Robot Skills Matches* on a given *Field*.
  - If an event is using multiple fields for *Robot Skills Matches*, the same method must be used at all *Fields*, as described in rule <RSC8>. Multiple V5 Robot Brains may be used as needed (e.g., a "Field 1 Brain" and a "Field 2 Brain").
  - The default "Drive" program accessed from a V5 Controller is intended for practice only, and may not be used for an official *Robot Skills Match*.
- If a *Team* chooses to utilize / record a *Skills Stop Time*, the 5-second grace period described in rule <SC1> does not apply.

## Robot Skills Challenge Ranking at Events

For each *Robot Skills Match*, *Teams* are awarded a score as described in the Robot Skills Challenge Scoring section, and an optional *Skills Stop Time* as described in the *Skills Stop Time* section. *Teams* will be ranked based on the following tiebreakers:

1. Sum of highest *Autonomous Coding Skills Match* score and highest *Driving Skills Match* score.
2. Highest *Autonomous Coding Skills Match* score.
3. Second-highest *Autonomous Coding Skills Match* score.
4. Second-highest *Driving Skills Match* score.
5. Highest sum of *Skills Stop Times* from a *Team's* highest *Autonomous Coding Skills Match* and highest *Driving Skills Match* (i.e., the *Matches* in point 1).
6. Highest *Skills Stop Time* from a *Team's* highest *Autonomous Coding Skills Match* (i.e., the *Match* in point 2).
7. Third-highest *Autonomous Coding Skills Match* score.

8. Third-highest *Driving Skills Match* score.
9. If a tie cannot be broken after all above criteria, then the following ordered criteria will be used to determine which *Team* had the "best" *Autonomous Coding Skills Match*:
  - a. Number of *Rings Scored*
  - b. Number of *Mobile Goals Scored*
  - c. *Climb Level* (for VURC & VAIRC, *Climb Level* of the highest *Robot*)
- If the tie still isn't broken, the same process in Step 9 will be applied to each *Team's* best *Driving Skills Match*.
- If the tie still isn't broken, events may choose to allow *Teams* to have one more deciding *Driving Skills Match*, to be ranked according to the standard criteria above, or declare both *Teams* the Robot Skills Challenge Winner.

# Robot Skills Challenge Ranking Globally

*Teams* will be ranked globally based on their Robot Skills scores from Tournaments and Leagues that upload results to [robotevents.com](https://robotevents.com), according to the following tiebreakers:

1. Highest Robot Skills score (combined *Autonomous Coding Skills Match* and *Driving Skills Match Score* from a single event).
2. Highest *Autonomous Coding Skills Match* score (from any event).
3. Highest sum of *Skills Stop Times* from the *Robot Skills Matches* used for point 1.
4. Highest *Skills Stop Time* from the *Autonomous Coding Skills Match* used for point 2.
5. Highest *Driving Skills Match* score (from any event).
6. Highest *Skills Stop Time* from the *Driving Skills Match* score used for point 5.
7. Earliest posting of the Highest *Autonomous Coding Skills Match* score.
  - a. The first *Team* to post a score ranks ahead of other *Teams* that post the same score at a later time, all else being equal.
8. Earliest posting of the Highest *Driving Skills Match* score.
  - a. The first *Team* to post a score ranks ahead of other *Teams* that post the same score at a later time, all else being equal.

## League Events

At league events in which *Teams* may submit Robot Skills Challenge scores across multiple days / sessions, the Robot Skills scores (combined highest *Autonomous Coding Skills Match* and *Driving Skills Match* scores) used for rankings will be calculated from *Matches* within the same session.

For example, consider the following scores for a hypothetical *Team* across two league event sessions:

	Autonomous Coding Skills Match	Driving Skills Match	Robot Skills Score
Session 1	100	100	200
Session 2	150	40	190

This *Team* would have a Robot Skills score of 200 for this event, and their scores from Session 1 would be used for the Event and Global tiebreakers listed in the above two sections.

# Section 6 - VEX U Robotics Competition

## Introduction

While many colleges and universities already use the VEX V5 system in their academic classes, many more have extensive manufacturing capabilities beyond the standard “VEX metal” library. Fabrication techniques like machining and 3D printing are more common than ever in collegiate engineering programs, and we can’t wait to see what VEX U Robotics Competition (VURC) *Teams* from around the world are able to create under these more advanced rules.

As in past years, the season will include a culminating VURC event at the VEX Robotics World Championship, along with regional tournaments across the world. Participating schools will get the chance to prove their abilities in front of thousands of future engineers and show off what truly makes their school remarkable. VURC is the perfect project-based supplement to many university level engineering programs, and will give *Students* the unique opportunity to demonstrate their real-world skills to potential employers (such as VEX competition sponsors).

## Event Information

Several of the University partners participating in VURC will be holding tournament events in addition to the capstone competition at the 2024 VEX Robotics World Championship. Refer to <https://www.robotevents.com/> for event details, pricing, and registration info for VURC events.

## Game, Robot, and Tournament Rules

VURC uses the VEX V5 Robotics Competition High Stakes *Field* with no modifications. Anyone that has a VEX V5 Robotics Competition High Stakes *Field* can use it for a VURC event or *Team*. Please consult the VEX V5 Robotics Competition High Stakes Game Manual for the basic set of competition rules and details.

All of the standard Game, Robot, & Tournament rules apply, except for the modifications listed in this document. In the event of a rules conflict, the rules listed in this document and rulings on the VURC Q&A take precedence.

## VURC Definitions

**Additional Electronics** - Any sensor, processor, or other electronic component used in *Robot* construction, and connected to the V5 Robot Brain, that is not sold by VEX Robotics. Examples could include commercially-available devices (e.g., Raspberry Pi) or custom devices designed and fabricated by the *Team*. See <VUR10> for more details.

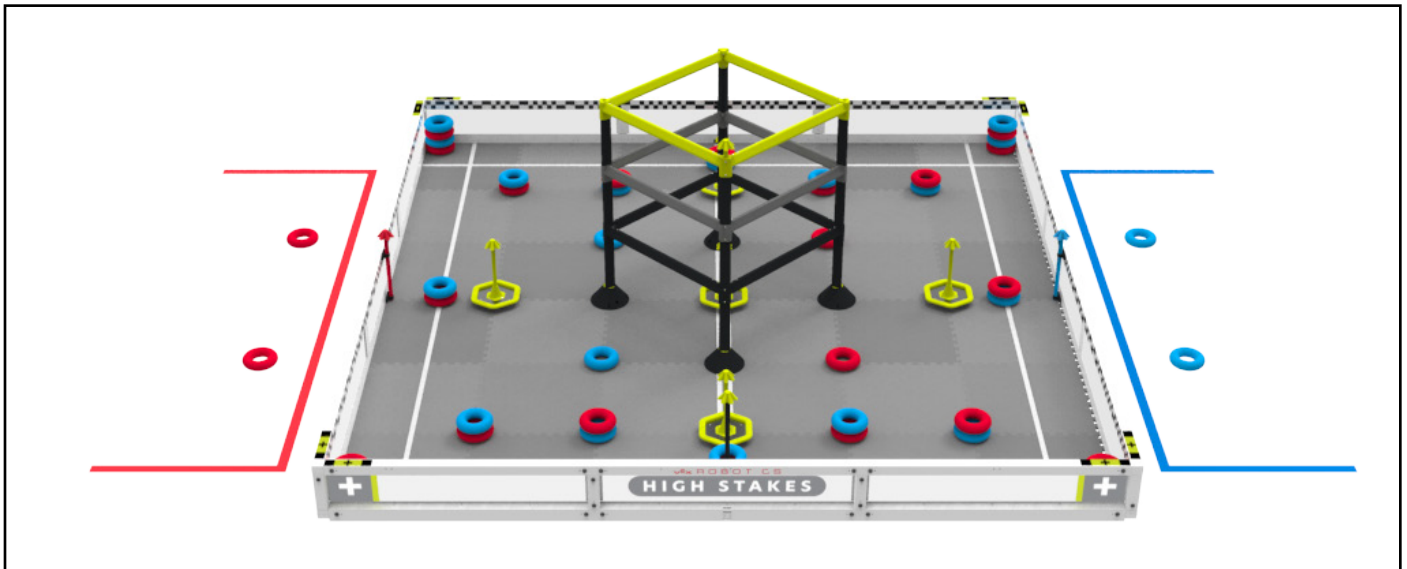
**Fabricated Part** - Any component used in *Robot* construction that is fabricated by *Team* members. See <VUR3>, <VUR4>, and <VUR5> for more details.

**Raw Stock** - Stock materials purchased from third-party vendors that may be used to create *Fabricated Parts*. See <VUR4>.

# Rule Modifications: Field Setup

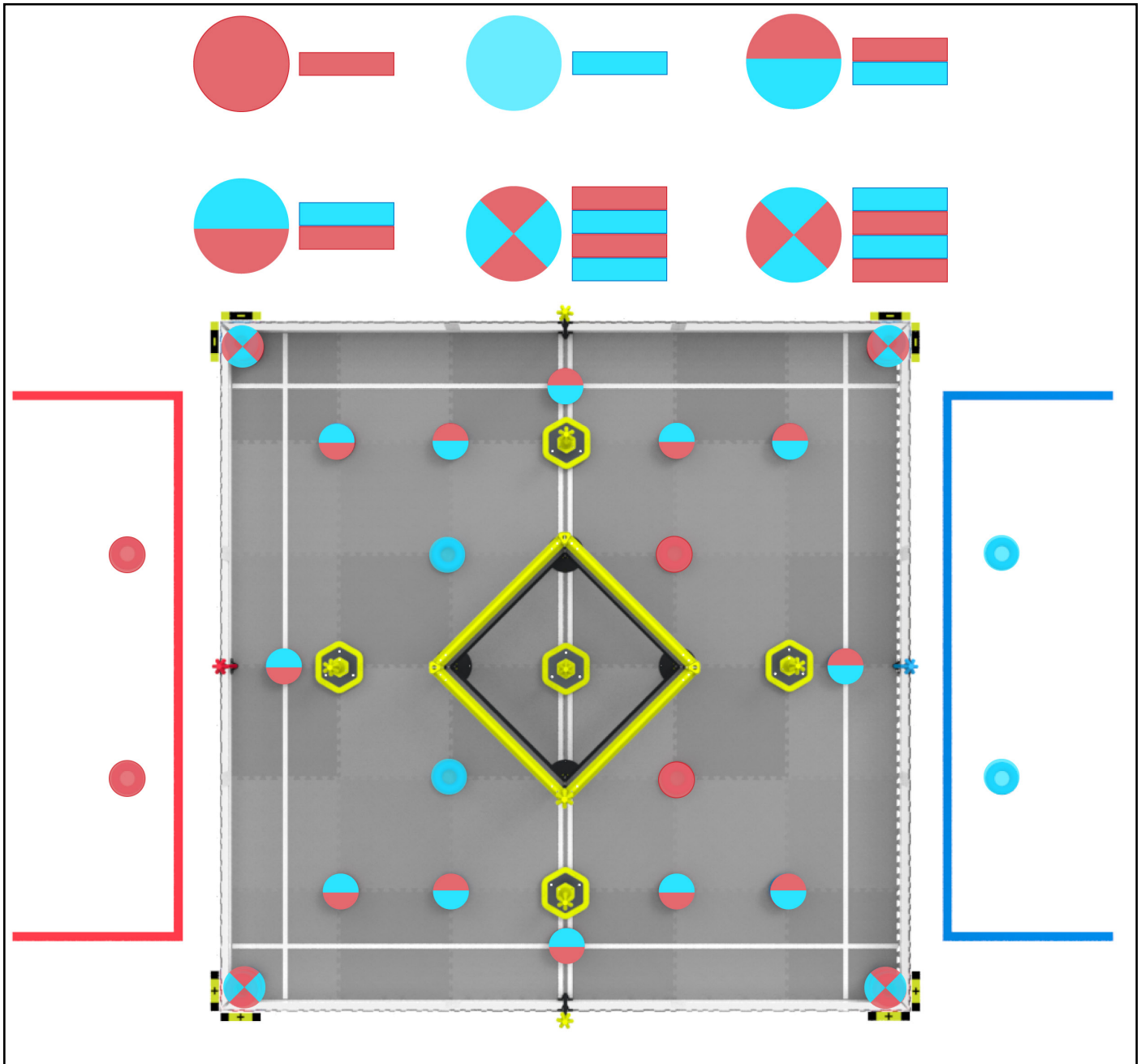
The VURC playing *Field* is set up differently than a Head-to-Head VEX V5 Robotics Competition High Stakes *Match*, with the following modifications as shown below.

- The VEX GPS code strip must be installed on the *Field*
- Modified *Field* layout





The image below is a Top view of the Field in its starting configuration for a VURC Match, with highlighted Rings (Red / Blue).



# Rule Modifications: Game

**<VUG1> Different expansion.** The intentions behind rules <SG2> and <SG3> apply, with the following clarifications:

- a. The 24" *Robot* may not expand horizontally outside this 24" x 24" limit at any time during the *Match*.
- b. The 15" *Robot* may expand horizontally with the same "one direction" rule as <SG2>. It may never exceed an overall footprint of 24" x 15".
- c. The intent of rule <SG3> applies to both *Robots*. Neither *Robot* may contact or "break the Plane of" three *Levels*, or two non-sequential *Levels*, of the *Ladder* at any time.

*Note: It may be physically possible for a 24" Robot to incidentally violate rule <SG3>, even without expanding vertically. Unintentional / minor infractions that only involve breaking a third plane will not be penalized, provided that clause C of this rule is followed at all times.*

## Significant Q&As

- [2058](#) - An undersized Robot designated as 24" may expand horizontally up to 24" in a single direction

**<VUG2> Different climbing.** All rules and point values pertaining to *Climbing* apply as written, with the following modifications:

- a. Clause A of <SC7> does not apply in VURC. *Robots* are not required to be contacting the *Ladder* at the end of the *Match* in order to receive points for *Climbing*. *Robots* not contacting the *Ladder* or foam tiles must be contacting another *Robot* from their *Team* that meets all criteria of <SC7>.
- b. A *Robot* which meets all other *Climbing* requirements, but is not contacting the *Ladder* at the end of the *Match*, will have their *Climbing* points doubled.
  - i. For example, when both *Robots* reach a standard *Level 2*, the *Team* would receive 12 points total (6 per *Robot*). If instead, both *Robots* have reached *Level 2* and one of them is not contacting the *Ladder*, the *Team* should receive 18 points total (6 + 12).
- c. In the context of rule <SG9>, a *Robot* which is in the process of *Climbing* without contacting the *Ladder* should be considered more "offensive" or "safe".

## Significant Q&As

- [2047](#) - Both the Climb points and the High Stake bonus are doubled under <VUG2b>

**<VUG3> Different autonomous.** Rule <SC2> applies as-written, except for clause A. *Climb* points and *Corner* modifiers are included in *Autonomous Bonus* calculations.

# Rule Modifications: Robot

<VUR1> Teams may use **two (2) Robots in each Match**.

- a. Both *Robots* may only be built from the following materials:
  - i. Official VEX Robotics products (see <VUR2>
  - ii. *Fabricated Parts* made by the *Team* (see <VUR3> through <VUR7>)
  - iii. Commercially-available springs, fasteners and bearings (see <VUR8>, <VUR9>, and <VUR14>).
  - iv. A legal electronics system (see <VUR10> and <VUR11>)
  - v. Any legal *Additional Electronics* (see <VUR12>)
  - vi. A legal pneumatics system (see <VUR13>)
- b. One *Robot* must be smaller than 24" x 24" x 24" at the start of the *Match*
- c. One *Robot* must be smaller than 15" x 15" x 15" at the start of the *Match*

*Note:* <SG2> applies as written to both *Robots*.

<VUR2> Teams may use **any official VEX Robotics products**, other than the exceptions listed in the tables below, to construct their *Robot*. This includes those from the VEXpro, VEX IQ, VEX GO, VEX 123, VEX CTE, VEX AIM, VEX AIR, and VEX Robotics by HEXBUG\* product lines. To determine if a product is "official" or not, refer to [www.vexrobotics.com](http://www.vexrobotics.com). Rule <R16> applies, and most modifications to non-electrical components are allowed.

SKU	Description	SKU	Description
217-8080	Talon SRX	217-4347	775pro
217-9191	Victor SPX	217-2000	CIM Motor
217-9090	Victor SP	217-3371	Mini CIM Motor
217-4243	Pneumatic Control Module	217-3351	BAG Motor
217-4244	Power Distribution Panel	217-6515	Falcon 500
217-4245	Voltage Regulator Module		

This rule takes precedence over all other rules regarding *Raw Stock* and/or *Fabricated Parts*, such as <VUR5>.

\* The HEXBUG brand is a registered trademark belonging to Spin Master Corp

<VUR3> **Fabricated Parts** may be made by applying the following manufacturing processes to legal *Raw Stock*:

- a. Additive manufacturing processes, such as 3D printing.
- b. Subtractive manufacturing processes, such as cutting, drilling, routing, or machining.
- c. Bending, such as sheet metal braking or thermoforming.
- d. Attaching materials to one another, such as welding or chemically bonding (e.g., epoxy).
- e. Molding of non-metals, such as injecting polyurethane into a 3D printed mold.

<VUR4> *Fabricated Parts* must be made from legal **Raw Stock**. To be considered *Raw Stock*, the material must be purchased in one of the following forms before undergoing the fabrication processes listed in <VUR3>:

	Type	Shape / Profile	Examples
1	Sheet	Flat Plane	<ul style="list-style-type: none"> <li>• Sheet metal</li> <li>• 1/8" polycarbonate sheet</li> <li>• Plywood</li> </ul>
2	Solid Billet	"Thick" rectangular beam / block	<ul style="list-style-type: none"> <li>• 4" x 4" x 6" solid aluminum billet</li> <li>• 2" x 2" x 2" acetal block</li> </ul>
3	Solid Bar	"Thin" rectangular beam	<ul style="list-style-type: none"> <li>• 2x4 wood planks</li> <li>• 1/4" x 3" aluminum bars</li> </ul>
4	Hollow Bar	Hollow rectangular beam	<ul style="list-style-type: none"> <li>• 1" x 1", 1/32" wall aluminum box tube</li> </ul>
5	Solid Rod	Cylinder	<ul style="list-style-type: none"> <li>• 1/4" steel rod</li> <li>• 1/4" acetal rod</li> </ul>
6	Hollow Rod / Tube	Hollow Cylinder	<ul style="list-style-type: none"> <li>• Copper tubing</li> <li>• PVC pipe</li> </ul>
7	Angle	90° "L" shape	<ul style="list-style-type: none"> <li>• 1" x 1", 1/16" thickness aluminum angle</li> </ul>
8	U- / C-Channel	"U" or "C". <a href="#">See this Q&amp;A.</a>	<ul style="list-style-type: none"> <li>• 1/4" High x 1" Wide Aluminum U-Channel</li> </ul>
9	Non-Metal 3D Printer Filament	Thin cylinder	<ul style="list-style-type: none"> <li>• PLA or TPU filament</li> <li>• Composite nylon filament (e.g. Markforged Onyx™)</li> </ul>
10	Synthetic Polymer used for Molding	Liquid	<ul style="list-style-type: none"> <li>• Polyurethane</li> <li>• Silicone</li> </ul>

*Teams* are not required to exhaustively define the specific material type for each component of every *Fabricated Part* in their Engineering Notebook, as it should be obvious from the engineering drawings required by <VUR7>. However, unusual parts should be expected to receive increased scrutiny.

If any materials do not easily fall into one of these categories, then that is probably an indication that it is not intended to be a legal type of *Raw Stock*. If a *Team* cannot demonstrate that the component was made from a legal type of *Raw Stock*, then they will be asked to remove it from their *Robot*.

<VUR5> The following material types are **not considered Raw Stock**, and are therefore not permitted:

	Type	Examples
1	Any otherwise-legal <i>Raw Stock</i> that has been post-processed by drilling, machining, or otherwise removing material	<ul style="list-style-type: none"> <li>• Angle aluminum with regularly-spaced holes or slots</li> <li>• Perforated sheet metal</li> </ul>
2	Extrusions that do not fall under one of the categories listed in <VUR4>	<ul style="list-style-type: none"> <li>• Non-rectangular aluminum extrusions, such as 80/20, T-slot, or Octanorm</li> <li>• Gear stock</li> </ul>
3	Assembled items (or pre-arranged kits of unassembled items) that form a single, more complex component	<ul style="list-style-type: none"> <li>• Gearboxes</li> <li>• Claw mechanisms</li> <li>• Swerve drive modules</li> </ul>
4	Commercial Off-the-Shelf items that are intended to be used with minimal modification	<ul style="list-style-type: none"> <li>• Wheels</li> <li>• Gears</li> <li>• Timing belts and pulleys</li> </ul>
5	Materials that are intended to be cast or sintered	<ul style="list-style-type: none"> <li>• Resin / powdered-bed 3D printing</li> <li>• Molten aluminum used for sand casting</li> </ul>

*Note: <VUR2> takes precedence over this rule. Materials purchased from VEX Robotics that fall under one of these categories (e.g., VersaFrame pre-drilled extrusion) are permitted.*

In industry, terms like "*Raw Stock*", "*raw material*", and "*material stock*" are often used interchangeably, and cover an extremely broad scope of physical goods. The lists in <VUR4> and <VUR5> are intended to explain what specific material types and profiles fall under the defined term "*Raw Stock*" in the context of the VURC competition.

<VUR6> *Fabricated Parts* may not be made from *Raw Stock* which poses a **safety or damage risk** to the event, other *Teams*, or *Field Elements*. Examples of prohibited materials include, but are not limited to:

- a. Any material intended to produce flames or pyrotechnic effects
- b. Any material that is liquid at the time of the *Match*. Examples include hydraulic fluids, oils, greases, liquid mercury, and tire sealant
  - i. This does not include fabrication processes that involve the use of liquids, such as milling coolant or epoxy
- c. Any matter that shatters or otherwise presents an excessive field/safety hazard upon failure. Examples include fiberglass, acrylic, and carbon fiber sheet/tube stock
  - i. This rule refers specifically to material legality itself. Any potentially unsafe mechanisms made from legal *Raw Stock* may still be addressed by <S1> and <R6>

**<VUR7> Fabricated Parts must be made by Team members.** Any *Fabricated Parts* must be accompanied by documentation that demonstrates the *Team's* design and construction process for that *Fabricated Part*.

- a. The minimum acceptable form of documentation is an engineering drawing with multiple views for the part in question. These drawings may be included in a *Team's* Engineering Notebook or in a standalone appendix to the Engineering Notebook
- b. Any *Fabricated Part* must have been entirely designed and produced by *Team* members. For example, parts ordered by the *Team* and 3D printed by a third party would be prohibited
- c. *Teams* will be required to provide this documentation as requested by inspectors, *Head Referees*, or judges at any time at an event. Failure to provide acceptable documentation will result in the part being deemed illegal for use; therefore, <R3>, <R28>, and/or <G1> will apply

**<VUR8>** *Teams* may use **commercially available springs** on their *Robots*. For the purposes of this rule, a "spring" is any device used for storing and releasing elastic potential energy. Examples include, but are not limited to:

- a. Compression, tension, torsion, constant force, or conical springs made from spring steel
- b. Springs made from elastic thread or rubber, such as surgical tubing, bungee cords, or stretchable braided rope
- c. Closed-loop (pneumatic) gas shocks

*Note: Gas shocks are not considered pneumatic devices in the context of <VUR13>. Gas shocks may not be modified in any way.*

**<VUR9>** *Teams* may use **commercially available fastener hardware** on their *Robot*. Examples include (but are not limited to):

- Screws, nuts, rivets
- Hinges, pins, rod ends, threaded rods, hose clamps
- Ancillary fastener accessories, such as washers or spacers
- Adhesives such as epoxy, glue, or tape (when used to join together two parts)

If the primary function of the part is not "fastening", then <VUR5>, <VUR6>, and/or <VUR7> take precedence over this rule. Illegal examples include (but are not limited to):

- A prefabricated non-VEX wheel, even though it may technically connect tread to a shaft
- 80/20 extrusion; other items get "fastened to it", it is not the part doing the "fastening"
- Using grip tape to improve wheel traction

<VUR10> Each *Robot* must utilize exactly **one (1) V5 Robot Brain and up to two (2) V5 Robot Radios** connected to a V5 Controller.

- a. *Teams* must abide by the power rules noted in <R14> and <VUR12c>
- b. Wireless communication between *Robots* is permitted if using legal V5 Robot Brains / Robot Radios. No other types of wireless communication protocols (e.g., radio, Bluetooth, Wi-Fi) are permitted

<VUR11> There is **no restriction on the number of V5 Smart Motors (11W) [276-4840] and/or EXP Smart Motors (5.5W) [276-4842]** that *Robots* may use. No other motors, servos, or electronic actuators are permitted, including those sold by VEX (e.g., the 2-Wire 393 Motor).

*Note 1: Rule <R15> still applies in VURC. Teams may not modify Smart Motors, and must use official/unmodified gear cartridges*

*Note 2: Commercially available pneumatic actuators and pneumatic solenoids are permitted within the guidelines of <VUR13>*

*Note 3: Legal Additional Electronics may include their own motor, servo, or actuator, per <VUR12>*

<VUR12> There is **no restriction on sensors and other Additional Electronics** that *Robots* may use for sensing and processing, except as follows:

- a. Sensors and *Additional Electronics* MUST be connected to the V5 Robot Brain via any of the externally accessible ports (i.e., without any modification to the microcontroller). A sensor may be connected to a processing unit which then connects to the V5 Robot Brain
- b. Sensors and *Additional Electronics* CANNOT directly electrically interface with VEX motors and / or solenoid
- c. The additional sensors and electronics may only receive power from any of the following:
  - i. Directly from the V5 Robot Brain via any externally accessible port
  - ii. From an additional lithium ion, lithium iron or nickel metal hydride battery pack (only one (1) additional battery can be used for sensor/processing power). This additional battery pack must operate at a maximum of 12 volts nominal
- d. Only the V5 Battery can power the V5 Brain
- e. *Additional Electronics* which include a low-powered motor as an integral part of their primary sensing/processing function, such as an external processor's cooling fan or a spinning sensor, are permissible
  - i. Standalone motors which serve no additional sensing or processing functionality (e.g., using a commercially-available brushless motor in a drivetrain) are not considered legal *Additional Electronics*, and would be considered a *Violation* of <VUR11>

- f. Pneumatic solenoids are the only types of solenoids that are permitted as *Additional Electronics*. Solenoids used for any purpose other than opening and closing a pneumatic valve are considered an actuator and therefore prohibited, per <VUR11>

#### Significant Q&As

- [2031](#) - Purchased odometry pods or components are not legal, but an encoder sensor is

<VUR13> *Teams* may utilize an **unlimited amount of the following commercially available pneumatic components**: cylinders, actuators, valves, gauges, storage tanks, regulators, manifolds, tubing, and solenoids.

- Pneumatic devices may only be charged to a maximum of 100 psi
- Compressors or any other forms of "on-Robot" charging are not permitted
- All commercial components must be rated for 100 psi or higher. *Teams* should be prepared to provide documentation that verifies these ratings to inspectors if requested
- Components must not be modified from their original state, other than the following exceptions:
  - Cutting pneumatic tubing or wiring to length; assembling components using pre-existing threads, brackets, or fittings; or minor cosmetic labels
- If commercially available 12V solenoids are used, these are considered *Additional Electronics* and must therefore satisfy all conditions listed in <VUR12>. 12V solenoids may be either powered by an additional power source (per <VUR12c>), or by a 5V-12V step-up converter from the V5 Robot Brain. If an external power source (or other *Additional Electronics* device) is used to interface with the solenoid, *Teams* MUST be able to demonstrate that there is no way for the solenoid to receive power while the *Robot* is receiving a *Disabled* state from the field controller

<VUR14> **Teams may use commercially available bearings on their Robot.** For the purpose of this rule, a 'bearing' is a part that supports external loads, reduces friction, and improves efficiency by facilitating smooth dynamic motion between components. Legal examples include (but are not limited to):

- Parts supporting rotational motion: radial bearings, roller bearings, thrust bearings, needle bearings, one-way bearings, bushings, etc.
- Parts supporting linear motion: linear bearings, linear slides, drawer slides, etc.



# Rule Modifications: Tournament

**<VUT1>** Instead of a *2-Team Alliance* format, VURC *Matches* will be played *1-Team vs. 1-Team*. Each *Team* will use two (2) *Robots* in each *Match*.

- a. *Teams* are allowed to build as many *Robots* as they would like, but only two (2)—one of each size as described in <VUR1>—may be brought from the pit to the playing field for any *Match*.
- b. All *Robots* must pass inspection before they are allowed to compete.

**<VUT2>** *Qualification Matches* will be conducted in the same manner as in a V5RC tournament, but in the revised 1v1 format described in <VUT1>.

**<VUT3>** *Elimination Matches* will be conducted in the same manner as in a V5RC tournament, but without an *Alliance Selection*. At the end of the competition, one *Team* will emerge as the tournament champion.

**<VUT4>** The *Autonomous Period* at the beginning of each Head-to-Head *Match* will be 30 seconds (0:30).

- a. Human interaction with *Robots* during the *Autonomous Period* is strictly prohibited.
- b. If both *Teams* complete their routines before 30 seconds have elapsed, they have the option to signal that they wish to end the *Autonomous Period* early. Both *Teams* and the *Head Referee* must all agree on the "early stop." This is not a requirement, and the option must have been established for all *Teams* at the event, such as during the event meeting.

**<VUT5>** The *Driver Controlled Period* is shortened to 90 seconds (1:30) and immediately follows the *Autonomous Period*.

**<VUT6>** Each *Robot* is allowed up to three (3) *Drive Team Members* in the *Alliance Station* during a *Match*, as modified from <G8>.

**<VUT7>** VURC *Student* eligibility.

- a. All VURC *Team* members MUST be matriculated in a post-secondary school OR have earned a post-secondary education diploma, certificate, or other equivalent during the six (6) months preceding the VEX Robotics World Championship. The intent of this rule is to permit *Students* graduating mid-year to still be able to finish their competition season.
- b. Professionals not enrolled in post-secondary education are not eligible to participate on a VURC *Team*.

- c. *Students* who are dual-enrolled in both a secondary school and in post-secondary courses are not eligible to participate on a *VURC Team*.
- d. *VURC Team* members may only be on exactly one (1) *VURC Team* for the season. See <G4>.

## Rule Modifications: Robot Skills Challenge

All rules apply from Section 5: Robot Skills Challenge and Section 6: VURC, with no modifications other than those noted below. *Teams* are permitted to use both *Robots*, with up to three (3) *Drive Team Members* each in their *VURC Robot Skills Challenge Matches*, per <VUT1> , <VUT6>, and <VUR1>.

<**VURS1**> The *VURC Robot Skills Challenge* playing field layout differs from the layout for *V5RC Robot Skills Matches*, with the following modifications:

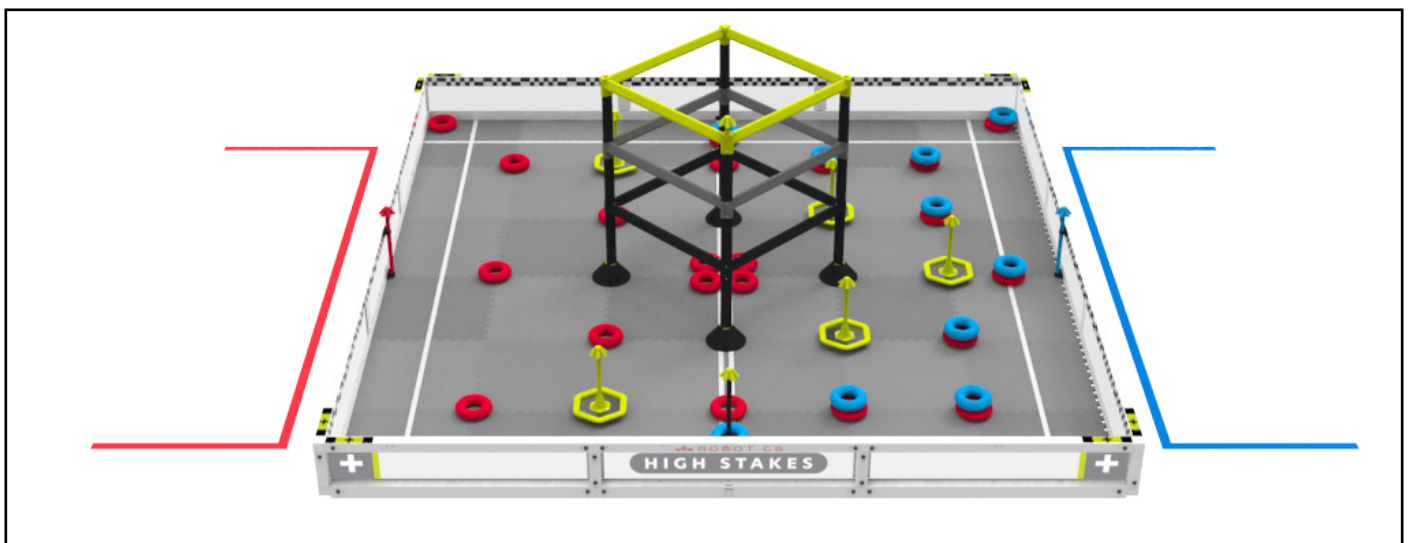
- a. Different starting locations for *Rings* and *Mobile Goals*
- b. Additional blue *Rings* are used

<**VURS2**> Both *Robots* must start the *Robot Skills Match* in legal starting positions for the red *Alliance*. All other portions of rule <SG1> apply.

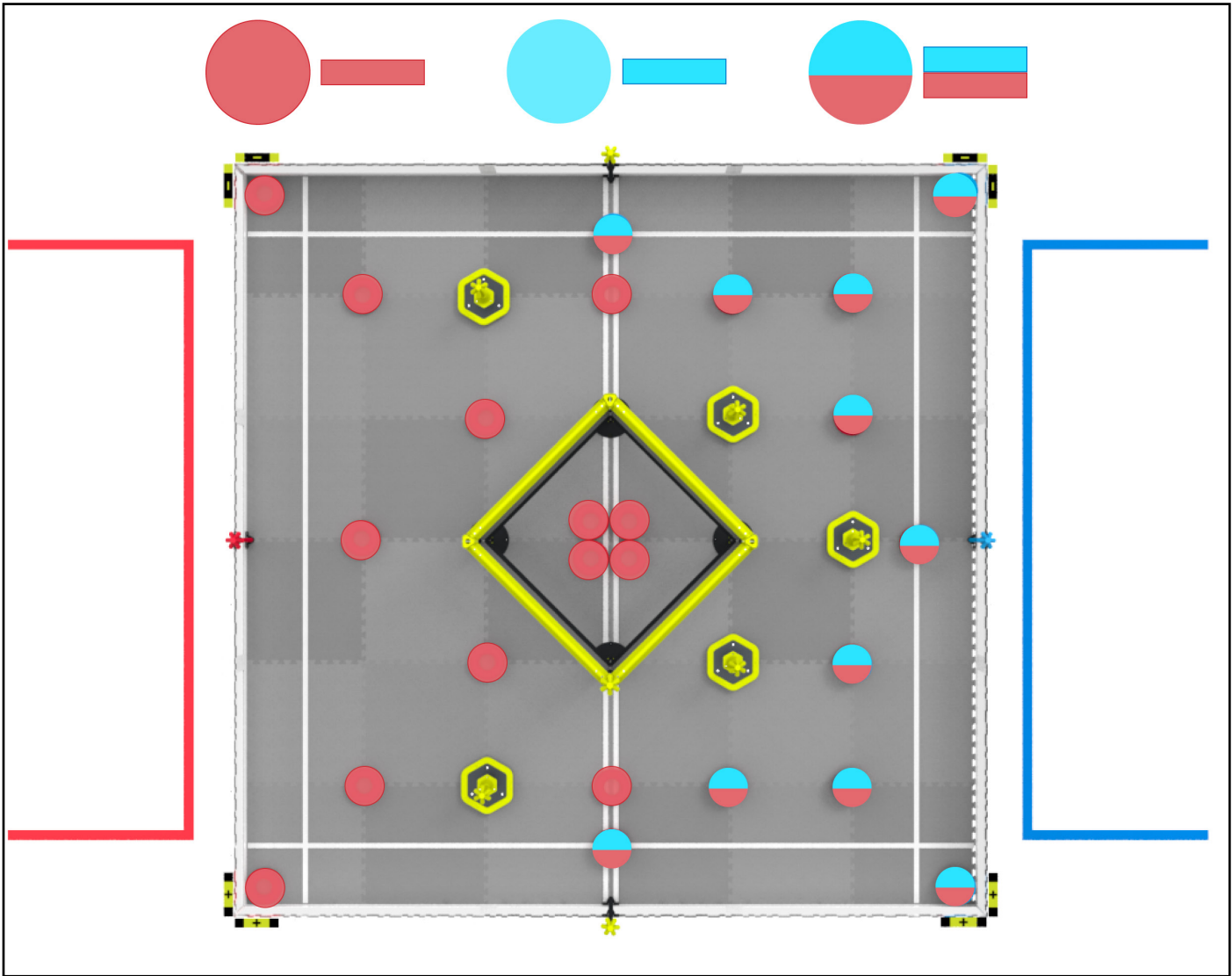
<**VURS3**> There are no preloads in *VURC Robot Skills Matches*.

<**VURS4**> Each blue *Ring* only has a point value if:

- a. All red *Rings* in the *Match* have been *Scored* on *Stakes* and have point values
- b. At least one red *Ring* is *Scored* below the blue *Ring(s)* on that *Stake*
- c. No red *Rings* are *Scored* above the blue *Ring(s)* on that *Stake*



The image below is a Top view of the Field in its starting configuration for a VURC *Robot Skills Match*, with highlighted Rings (Red / Blue).



## Team Composition

We want to see Universities face off in a global head-to-head competition. Schools are not limited to one *Team*, and a *Team* may consist of multiple colleges, but we hope that each *Team* identifies with and proudly represents one (1) post-secondary institution. (e.g., "Clarkson University" vs. "UC Santa Barbara"). Of course, college-level "club" *Teams* and mixed composition *Teams* are encouraged to join! However, as noted in <VUT7>, *Students* who have not yet graduated secondary school are not eligible to participate in VURC, even if they are "dual-enrolled" or taking post-secondary courses.

## Section 7 - VEX AI Robotics Competition

### Introduction

Artificial intelligence (AI) is becoming a staple in today's industry. The VEX AI Robotics Competition (VAIRC) gives *Teams of Students* a chance to compete in this growing field. With just a few additional sensors, *Teams* will be playing in one-vs-one *Matches* using two *Robots* per *Team* (i.e., four *Robots* on the *Field*) that are fully autonomous. *Robots* function without input from *Drive Team Members* and instead are communicating with each other as the *Match* progresses through two minutes. VAIRC is the perfect project-based supplement to many high school and university-level engineering programs, and gives *Students* the unique opportunity to demonstrate their real-world AI skills to potential employers (such as REC Foundation sponsors).

The 2024-2025 season may provide expanded opportunities for VAIRC competitors, such as VAIRC divisions at select VURC events and ways for *Teams* to submit Robot Skills Challenge scores at local V5RC events.

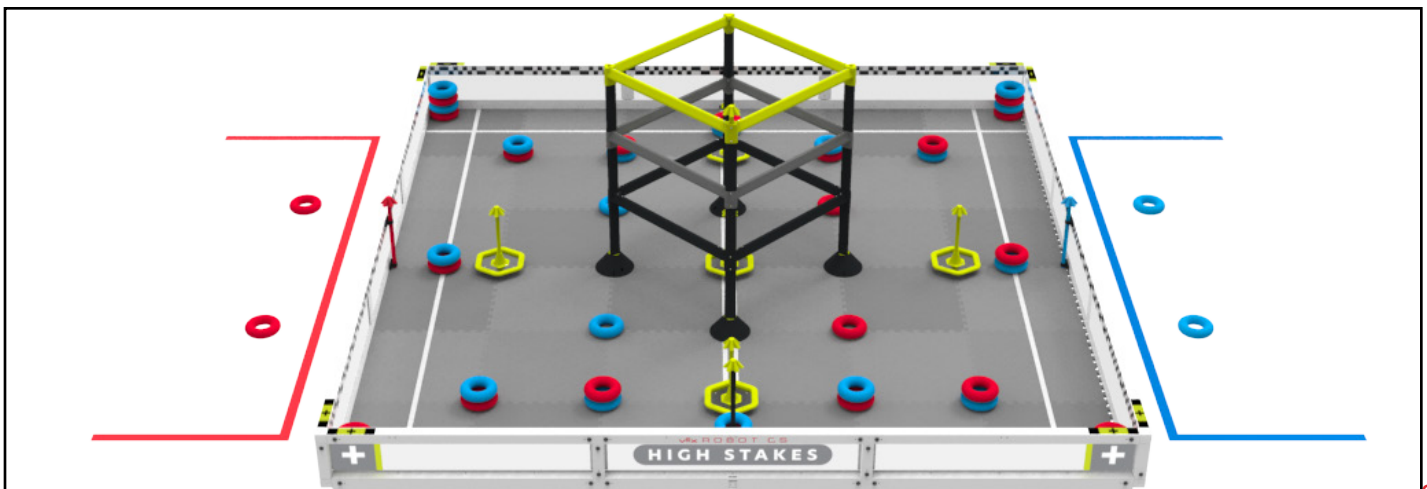
### Game, Robot, and Tournament Rules

Please consult the VEX V5 Robotics Competition High Stakes Game Manual for the basic set of competition rules and details. Most VAIRC rules are based on the VURC rules, which can be found in Section 6. As such, all standard VURC Game, Robot, & Tournament rules apply, except for the modifications listed in this document. In the event of a rules conflict, the rules listed in this document and rulings on the VURC Q&A take precedence.

### Rule Modifications: Field Setup

The VEX AI Robotics Competition uses a standard V5RC High Stakes field, set up the same as a VURC *Match*, as shown below and in Section 6.

A VEX GPS Code Strip and opaque field panels are required for VAIRC *Matches*. Although the V5RC Portable Field Perimeter is preferred, as it already meets these criteria, a metal field perimeter may be used if modified accordingly.



# Game Definitions

**Base Team** - A V5RC or VURC *Team* whose members also compete in VAIRC on a *Crossover Team*.

**Crossover Team** - A VAIRC *Team* whose members also compete on a V5RC or VURC *Base Team*. See rules <VAIR3> and <VAIT3>.

**Interaction Period** - The 90-second (1:30) time period that follows the *Isolation Period* after the winner of the *Isolation Period* has been determined. *Robots* react only to sensor inputs and to commands pre-programmed by the *Students* into the *Robot* control system and can interact with the entire *Field* during the *Interaction Period*. The *Interaction Period* replaces the *Driver Controlled Period* that occurs in V5RC and VURC *Matches*.

**Isolation Bonus** – A point bonus of six (6) points awarded to the *Team* that has earned the most points at the end of the *Isolation Period*. The *Isolation Bonus* replaces the *Autonomous Bonus*.

**Isolation Win Point** – One (1) *Win Point* (WP) given to an *Alliance* that has completed the *Autonomous Win Point* criteria set forth in rule <SC8>. The *Isolation Win Point* replaces the *Autonomous Win Point*.

**Isolation Period** - A 30-second (0:30) time period during which *Robots* operate only on their side of the *Field* and react only to sensor inputs and to commands pre-programmed by the *Students* into the *Robot* control system. This *Isolation Period* replaces the *Autonomous Period* normally found in a VURC *Match*.

## Rule Modifications: Game

<VAIG1> All <VUGx>, <SCx>, and <Sx> and rules apply as written. All <Gx> and <SGx> rules apply as written, except for those modified below or by <VUGx> rules.

*Note: All references assume that the terms "Autonomous Period" and "Driver Controlled Period" are replaced with "Isolation Period" and "Interaction Period", respectively.*

<VAIG2> As noted by <G11>, *Drive Team Members* are not permitted to interact with their *Robots* in any way while they are operating autonomously (i.e., during the entirety of a VAIRC *Match*). The following exceptions are permitted:

- a. Using a V5 Controller to disable a *Robot* which is engaging in reckless or unsafe behavior. *Robots* which are disabled may not be re-enabled for the rest of the *Match*.

**<VAIG3>** Just as V5RC and VURC *Teams* are responsible for the actions of their *Robots* during the *Autonomous Period*, VAIRC *Teams* are responsible for the actions of their *Robots* throughout the entirety of a VAIRC *Match*. Excessive or egregious *Violations* of the following rules may result in a *Major Violation / Disqualification*, as well as the *Head Referee* directing a *Team* to disable their *Robot*:

- a. <G13> Don't destroy other *Robots*
- b. <G16> No *Holding* for more than a 5-count
- c. <SG7> Don't cross the *Autonomous Line*

In the context of this rule, "excessive or egregious" refers to a *Violation* or interaction that the *Head Referee* has judged to be out of the *Robot's* control and/or is not showing any signs of improvement. Examples may include, but are not limited to:

- *Holding* an opponent for 15+ seconds
- Repeated *Violations* of <SG7> across multiple *Matches*

Based on game play in prior VAIRC seasons, it is recommended that *Teams* add lines of code that will attempt to back their *Robot* up or remove it from a situation if the *Robot* doesn't move after a specified number of seconds. This can help prevent *Disqualifications* for extended *Holding*.

**<VAIG4>** In VAIRC head-to-head *Matches*, each *Alliance's Robots* may only *Climb* the portions of the *Ladder* that are on their *Alliance's* side of the *Autonomous Line*.

## Rule Modifications: Tournament

**<VAIT1>** The following VURC rules apply as written:

- <VUT1> *Matches* are played 1-*Team* vs 1-*Team*, with two *Robots* each.
- <VUT2> *Qualification Matches* are a 1v1 version of a standard V5RC tournament.
- <VUT3> *Elimination Matches* are a 1v1 version of a standard V5RC tournament.
- <VUT6> Each *Robot* is permitted up to three (3) *Drive Team Members*.

The following VURC rules apply, replacing the terms "*Autonomous Period*" and "*Driver Controlled Period*" with "*Isolation Period*" and "*Interaction Period*", respectively:

- <VUT4> The *Autonomous Period / Isolation Period* is 30 seconds.
- <VUT5> The *Driver Controlled Period / Interaction Period* is 90 seconds.

**<VAIT2>** VEX AI Robotics Competition *Teams* may consist of *Students* that fall into one of the following categories:

- a. *High School Students*, as described by the definition of *Student*. This includes *Middle School Students* who are "playing up" and competing as *High School Students*.
- b. *University Students*, as defined by rule <VUT7>.

*Note: The same Team may not consist of Students that fall into both categories (i.e., a blended High School and University Team).*

**<VAIT3>** *Students* may only participate on one (1) VAIRC *Team* in a given season. However, *Students* on *Crossover Teams* are still permitted to participate on their *Base Team*.

It is expected that VAIRC *Teams* will be formed by existing V5RC and VURC organizations. The term "*Crossover Team*" is intended to clarify that *Students* will not have to "choose" between V5RC/VURC and VAIRC, e.g., in the context of <G4> or <VUT7>.

However, if a *Crossover Team* and the associated *Base Team* both attend an event which has concurrently scheduled *Matches* between the two programs, *Students* (especially *Drive Team Members*) should be expected to choose which *Team* they are representing for the duration of that event. "Our driver is in a VAIRC *Match*" would not be considered an acceptable justification for being late to a V5RC/VURC *Match* (or vice-versa).

*Note: See <VAIR3> for more details regarding how this rule pertains to Robots.*

## Rule Modifications: Robot

**<VAIR1>** All <VURx> rules apply as written. All <Rx> rules apply as written, except for those modified below or by <VURx> rules.

**<VAIR2>** Any components used for AI vision processing, such as those found in the VEX AI kit (276-8983), are considered standard *Additional Electronics* and must abide by <VUR12> as written.

**<VAIR3>** Although VAIRC *Crossover Teams* are encouraged to build separate *Robots* from their *Base Team* counterparts, it is not required. The *Robot(s)* built by a *Base Team* may be used by their associated *Crossover Team* for VAIRC *Matches*. Therefore, <R1> does not "cross programs" between VAIRC *Teams* and their associated V5RC *Base Team*.

*Note: This allowance is "one-way" for VAIRC Matches. Participation in VAIRC does not create any exemption for V5RC Matches and events. For example, <R1c> still applies; a V5RC Base Team may not switch between their Crossover Team's other VAIRC Robot(s) for different V5RC Matches.*

If a *Crossover Team* and the associated *Base Team* attend an event which has concurrently scheduled *Matches* between the two programs, *Teams* would be advised to have separate *Robots* for each *Team*. *Event Partners* will not be expected to adjust *Match* schedules around *Team* conflicts between the two programs; "our *Robot* is in a VAIRC *Match*" would not be considered an acceptable justification for being late to a V5RC/ VURC *Match* (or vice-versa).



# Appendix A - Field Overview

## Game Field Introduction

This document will provide Bill of Materials (BOM) information and detailed specifications for the Official Competition Field.

*Teams* who do not need an “official” field should refer to the separate low-cost field guide for cost reduction options. *Teams* assembling the full *Field* should refer to the separate VEX V5 Robotics Competition High Stakes Field Build Instructions.

Please note: this *Field* can utilize both the [VEX Portable Competition Field Perimeter \(276-8242\)](#) and the VEX Competition Field Perimeter (278-1501) developed by VEX Robotics. Instructions and specifications for these field perimeters are available in separate documents and are important for the field assembly.

This document is divided up into three sections:

1. *Field* Overview
2. *Field* BOM
3. *Field* Specifications

There is also an accompanying STEP file which can be imported into most 3D modeling programs (e.g., Inventor, Sketchup, Solidworks, etc.). This 3D model shows the “official” setup of a VEX V5 Robotics Competition - High Stakes competition field, as well as detailed models of individual *Field Elements*.

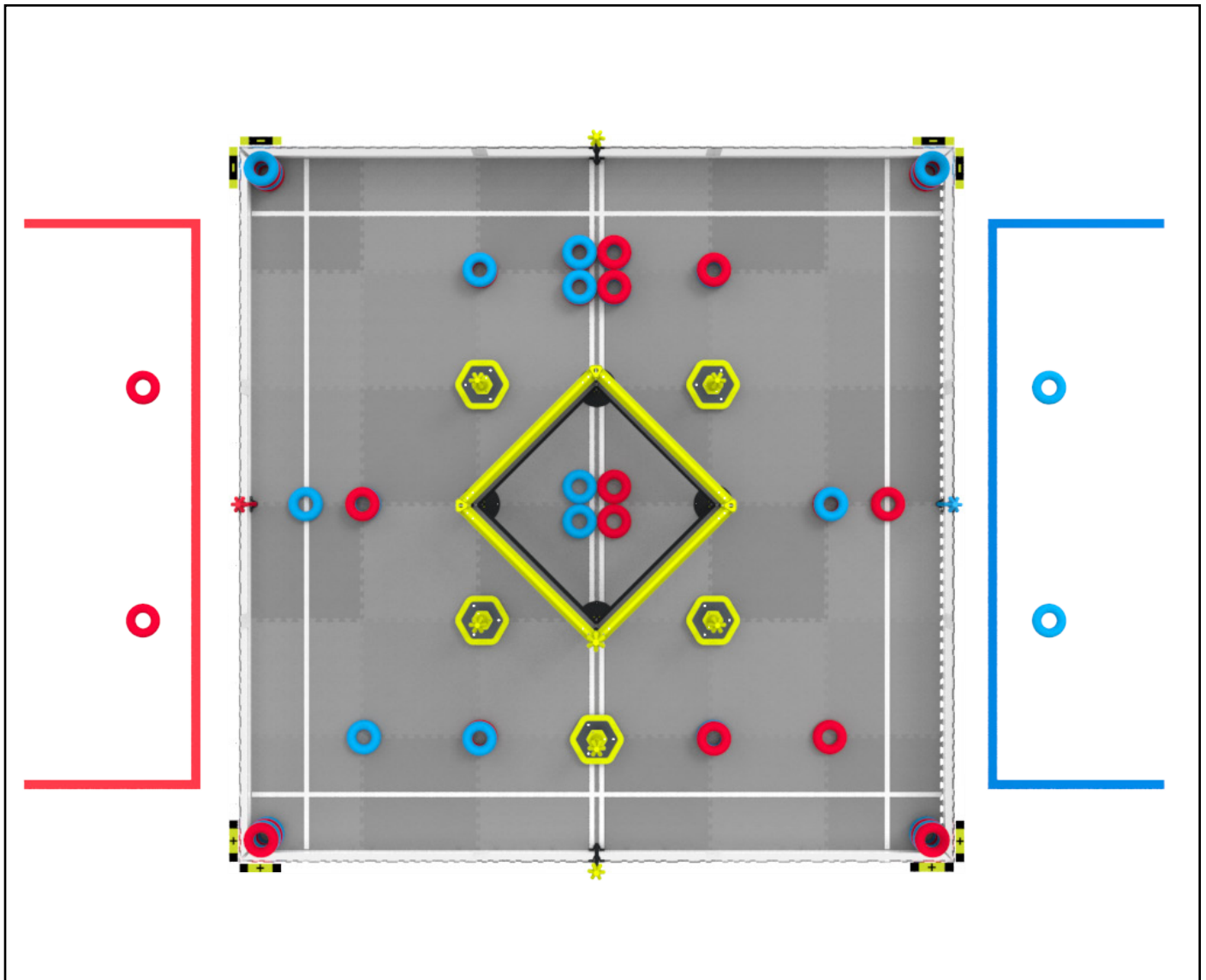
For additional game-play detail, please refer to the VEX V5 Robotics Competition High Stakes Game Manual.

# Field Overview

V5RC High Stakes is played on a 12ft x 12ft foam mat, surrounded by a perimeter, with a *Ladder* in the center of the field.

The V5RC High Stakes field consists of forty-eight (48) Rings, five (5) Mobile Goals, four (4) Wall Stakes, and one (1) *Ladder*. Four (4) *Corners*, two (2) Positive and two (2) Negative, are taped off in each corner of the *Field Perimeter*.

For more details and specific gameplay rules, please refer to the V5RC High Stakes Game Manual.



# Game Objects & Field Bill of Materials

All of these items are available for purchase from [www.vexrobotics.com](http://www.vexrobotics.com)

## Generic Field Elements - Reusable Each Year

Part Number	Description
278-1501	Field Perimeter Frame & Hardware
276-8242	Portable Competition Field Perimeter
276-6905	Anti-Static Field Tiles (18-Pack)
275-1401	VEXnet Field Controller

## Official VEX V5 Robotics Competition High Stakes Specific Elements

Part Number	Description	Quantity per Full Field
276-8868	V5RC 2024-25 Full Field & Game Element Kit	
276-8869	V5RC 2024-25 Game Element Kit	1
276-8870	V5RC 2024-25 Field Element Kit 1	1
276-8871	V5RC 2024-25 Field Element Kit 2	1
276-9068	V5RC 2024-25 Field Element Kit 3	1
276-9091	V5RC Field Element Plates (4-Pack)*	1

\*Optional. Only needed if Field Element Plates are not already owned.

## Practice Elements

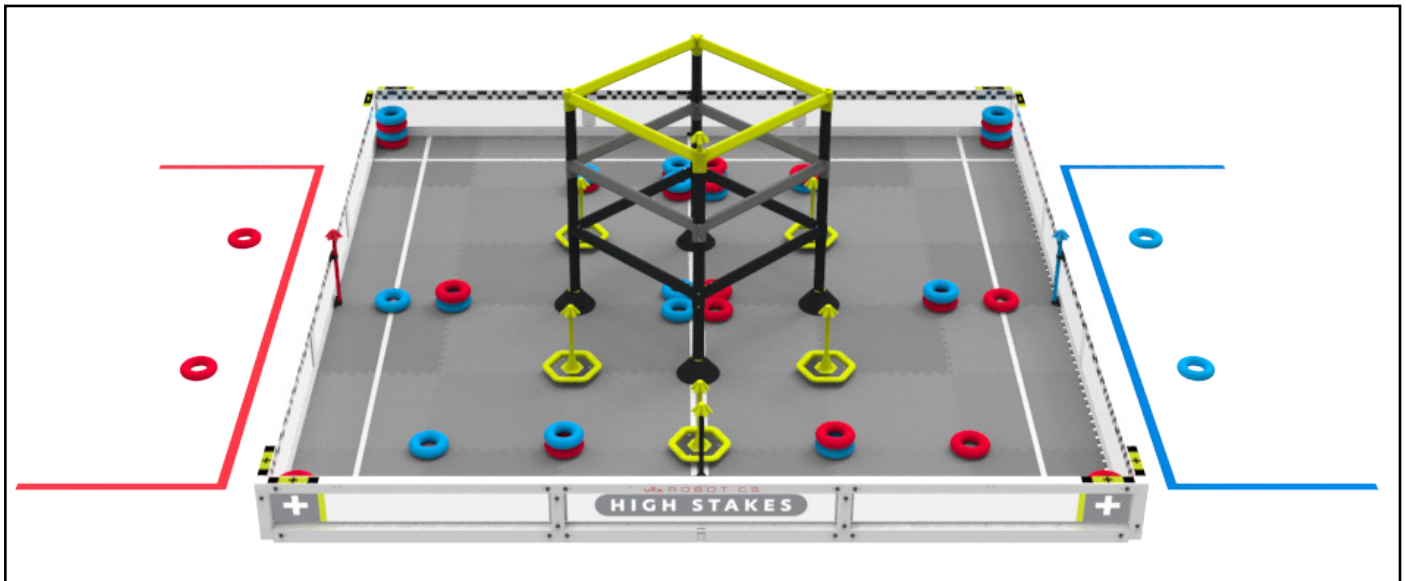
Part Number	Description
276-8869	V5RC 2024-25 Game Element Kit
276-8872	V5RC 2024-25 Scoring Element Kit

# Field Specifications Introduction

This section will outline the specifications that are most important to *Teams* designing a *Robot* to compete in the VEX V5 Robotics Competition High Stakes. Though many of the critical dimensions are included in this section, it may be necessary to consult the separate assembly guide and 3D CAD models of the *Field* for an additional level of detail. If you can't find a dimension in the specifications, we include a full model of the field to "virtually" measure whatever dimension is necessary.

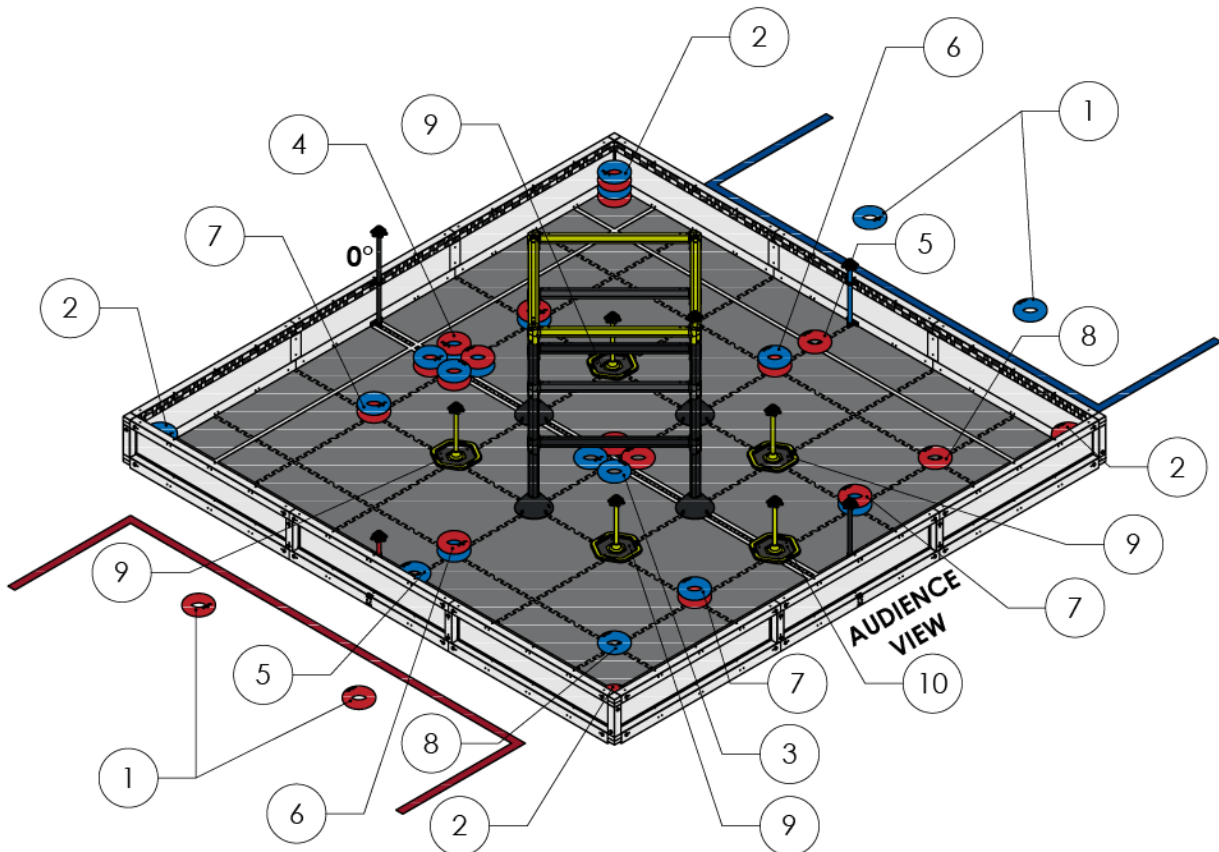
*Field* components may vary slightly from event to event. This is to be expected; *Teams* will need to adapt accordingly. It is good design practice to create mechanisms capable of accommodating variances in the *Field* and *Scoring Objects*.

*Note: Minor Field repairs are permissible, provided that the repairs do not affect gameplay. Examples of minor Field repairs include (but are not limited to) threadlocker applied to Field Element mounting hardware. Be sure to check the Official Q&A for specific examples or to get an official clarification.*



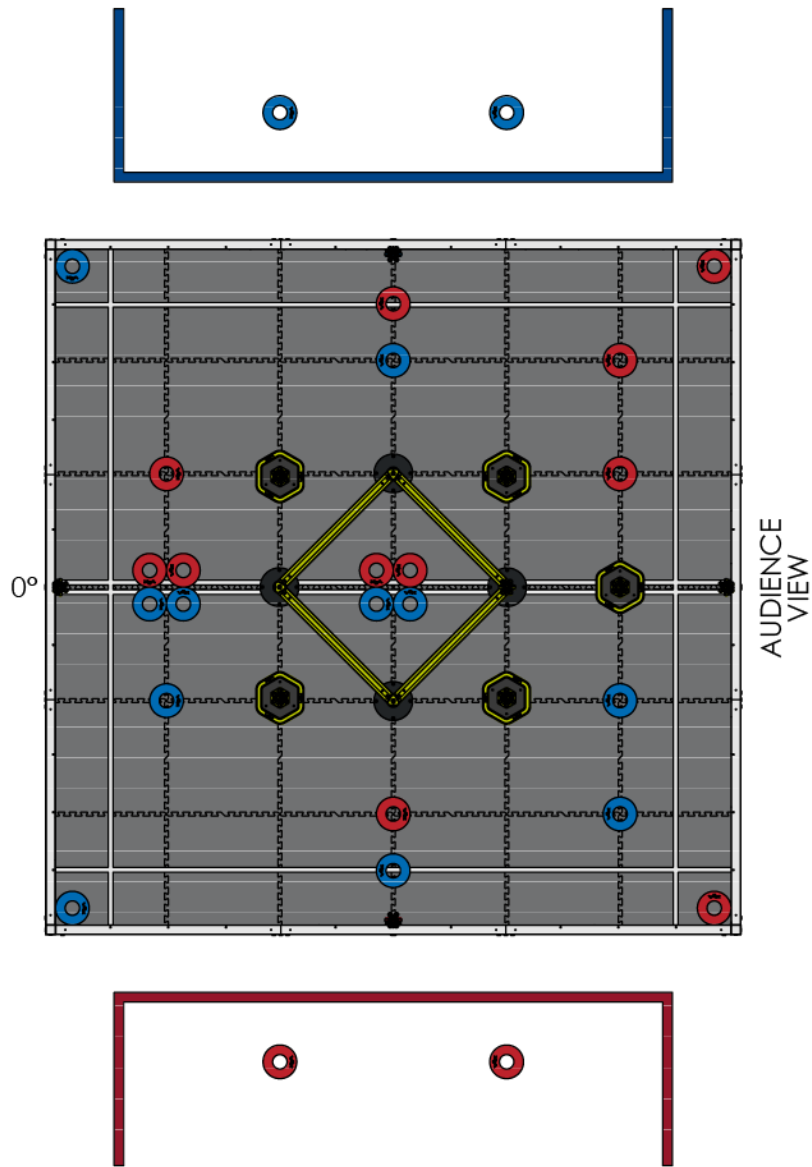
**Scoring Objects are placed as follows before the start of each Head-to-Head VRC Match**

1. (2x) Alliance colored Rings for Preload, (1x) per Team.
2. (4x) Rings in alternating colors placed in each Corner.
3. (4x) Rings placed at the center of the Field, under the Ladder. Blue Rings on red side and vice versa.
4. (8x) Rings between the Ladder and the Neutral Wall Stake opposite the Audience, stacked in sets of 2 with alternating colors. Blue Rings on top on red side and vice versa.
5. (1x) Ring of opposite Alliance color placed in front of each Alliance Specific Stationary Goal.
6. (2x) Rings of alternating colors placed between the Alliance Specific Wall Stakes and the Ladder. Red Ring on top on red side and vice versa.
7. (2x) Rings of alternating colors stacked, one tile away from the Autonomous Line in all 4 quadrants of the Field.
8. (1x) Ring of opposing Alliance color placed on the intersection of the tiles in front of each Corner.
9. (4x) Mobile Goals placed on the intersection of the tiles in front of each face of the Ladder.
10. (1x) Mobile Goal placed on center line in front of Neutral Wall Stake on Audience side of the Field.



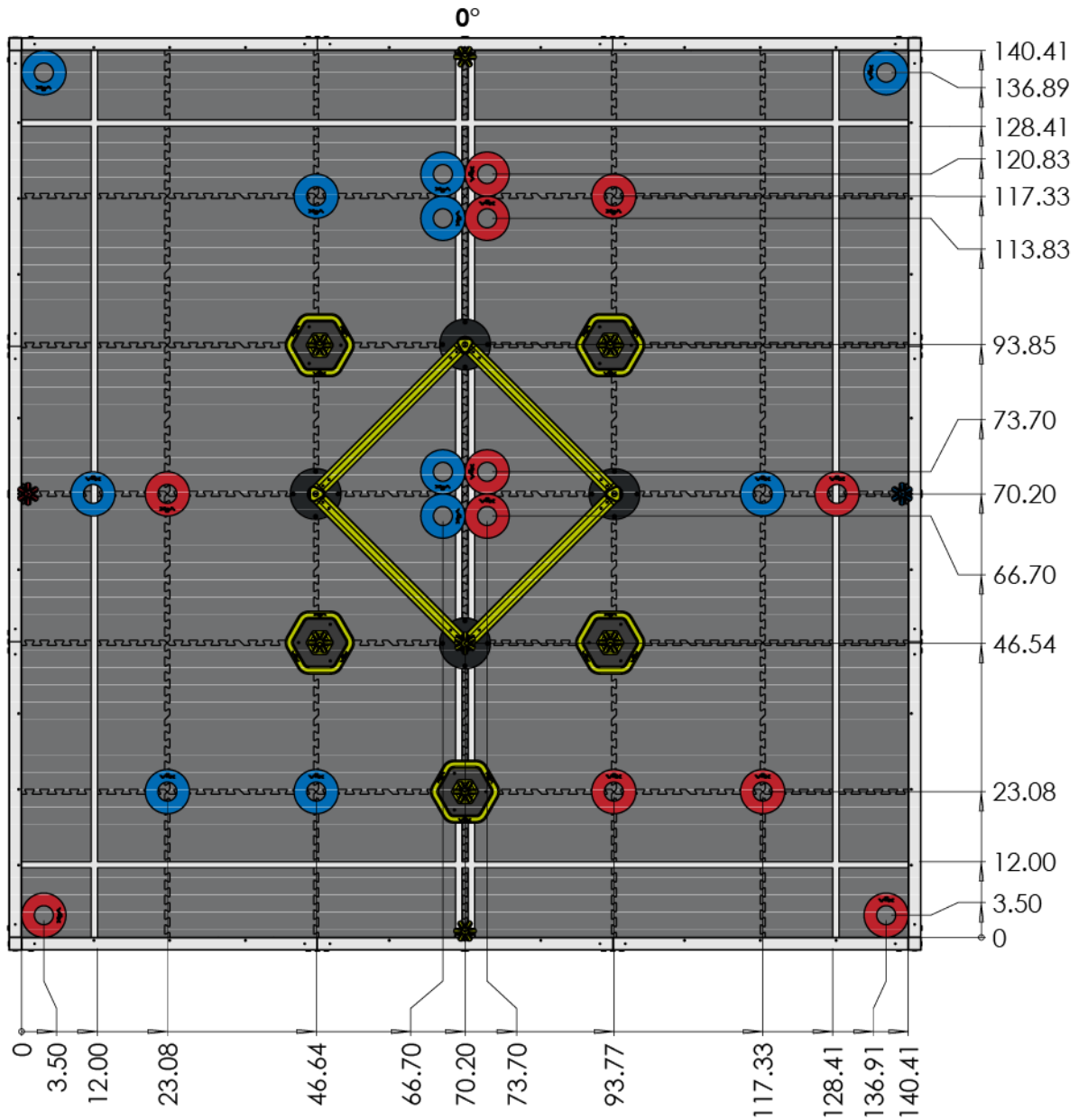
	Description	OBJECT PLACEMENT	
	Dwg No	276-8868 FIELD SPECIFICATIONS	
	Competition	VRC 2024-2025	SHEET 1 OF 15
	Release	2/15/2024	ALL DIMENSIONS ARE IN INCHES.

### Reference Object Placement Image, V5RC Head-to-Head Matches



	Description	OBJECT PLACEMENT (2)	
	Dwg No	276-8868 FIELD SPECIFICATIONS	
	Competition	VRC 2024-2025	
	Release	3/18/2024	ALL DIMENSIONS ARE IN INCHES.
			<a href="http://www.VEXROBOTICS.COM">www.VEXROBOTICS.COM</a>

FIELD REFERENCE SPECIFICATIONS

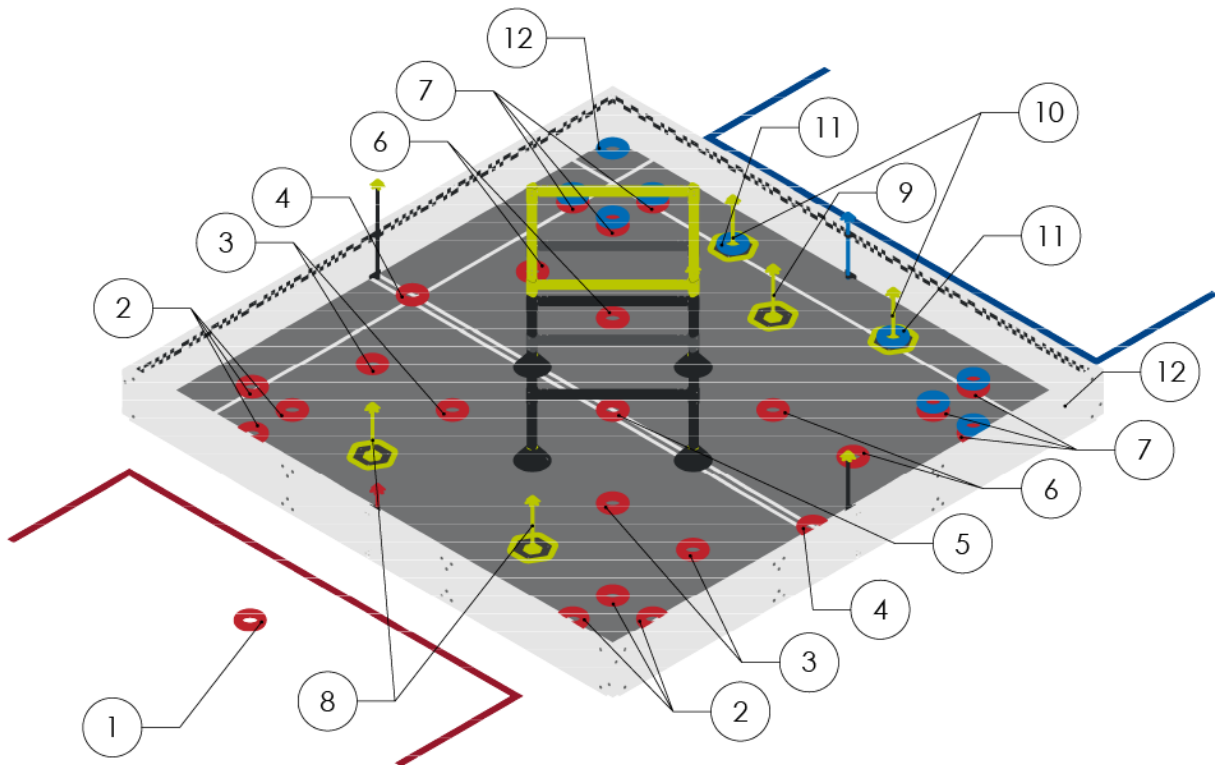



AUDIENCE VIEW

	Description	FIELD REFERENCE SPECIFICATIONS	
	Dwg No	276-8868 FIELD SPECIFICATIONS	
	Competition	VRC 2024-2025	
	Release	3/18/2024	ALL DIMENSIONS ARE IN INCHES.
			www.VEXROBOTICS.COM

**Scoring Objects are placed as follows before the start of each VRC Skills Match**

1. (1x) Red Ring for Preload.
2. (3x) Red Rings placed along the outside of the tile that contains the Corner on either side of the Field on the red Alliance side.
3. (4x) Rings placed along the tile junctions 2 tiles away from the red Alliance Wall
4. (1x) Red Ring placed in front of each Neutral Wall Stake.
5. (1x) Ring centered on the field, under the Ladder.
6. (4x) Rings placed along the tile junctions 2 tiles away from the Blue Alliance Wall.
7. (3x) Stacks of Blue Rings on top of Red Rings placed along the outside of the tile that contains the Corner on either side of the field on the Red Alliance Side
8. (2x) Mobile Goals one tile away from the red Alliance Wall.
9. (1x) Mobile Goal one tile away from the blue Alliance Wall Stake, centered on the Field.
10. (2x) Mobile goals placed on the Blue Starting Line, each one tile away from the blue Alliance Wall Stake.
11. (1x) Blue Ring placed on each Mobile Goal that starts on the blue Starting Line.
12. (1x) Blue Ring placed touching both field walls in each Corner on the blue Alliance side of the Field.

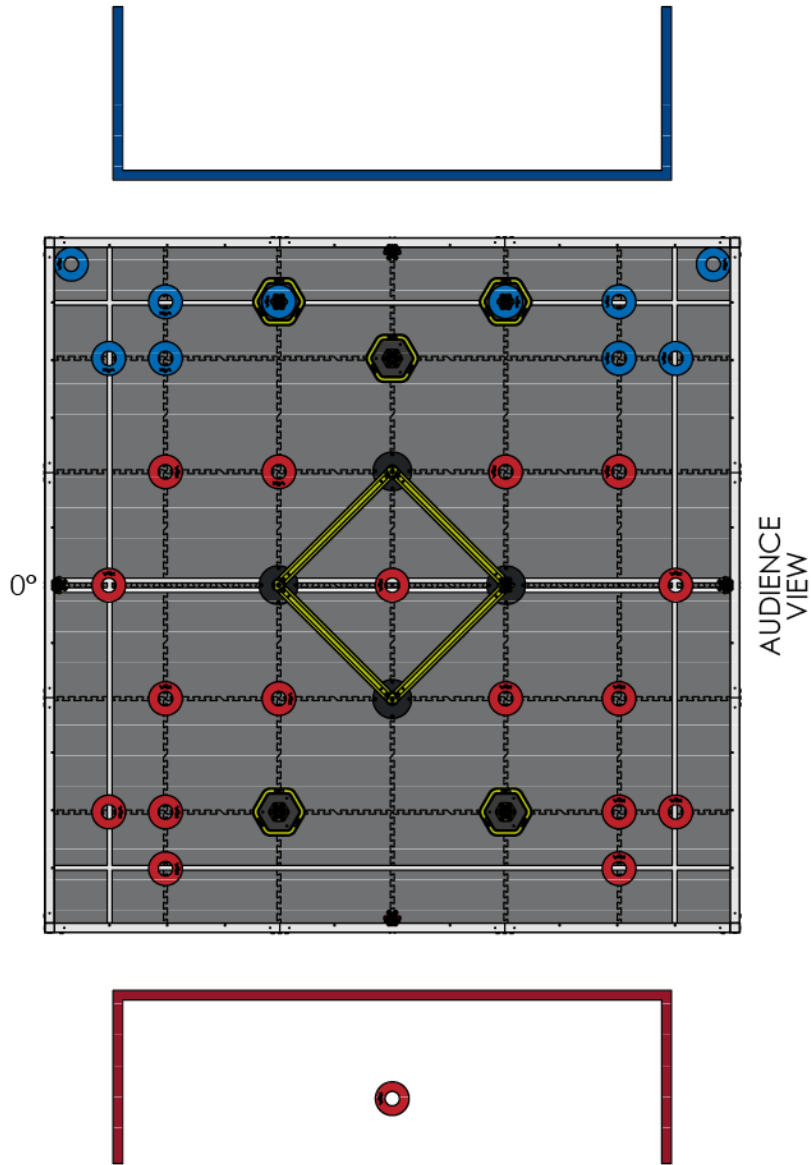


	Description OBJECT PLACEMENT - SKILLS	
	Dwg No 276-8868 FIELD SPECIFICATIONS	
	Competition VRC 2024-2025	SHEET 3 OF 15
	Release 2/15/2024	ALL DIMENSIONS ARE IN INCHES.

[www.VEXROBOTICS.COM](http://www.VEXROBOTICS.COM)



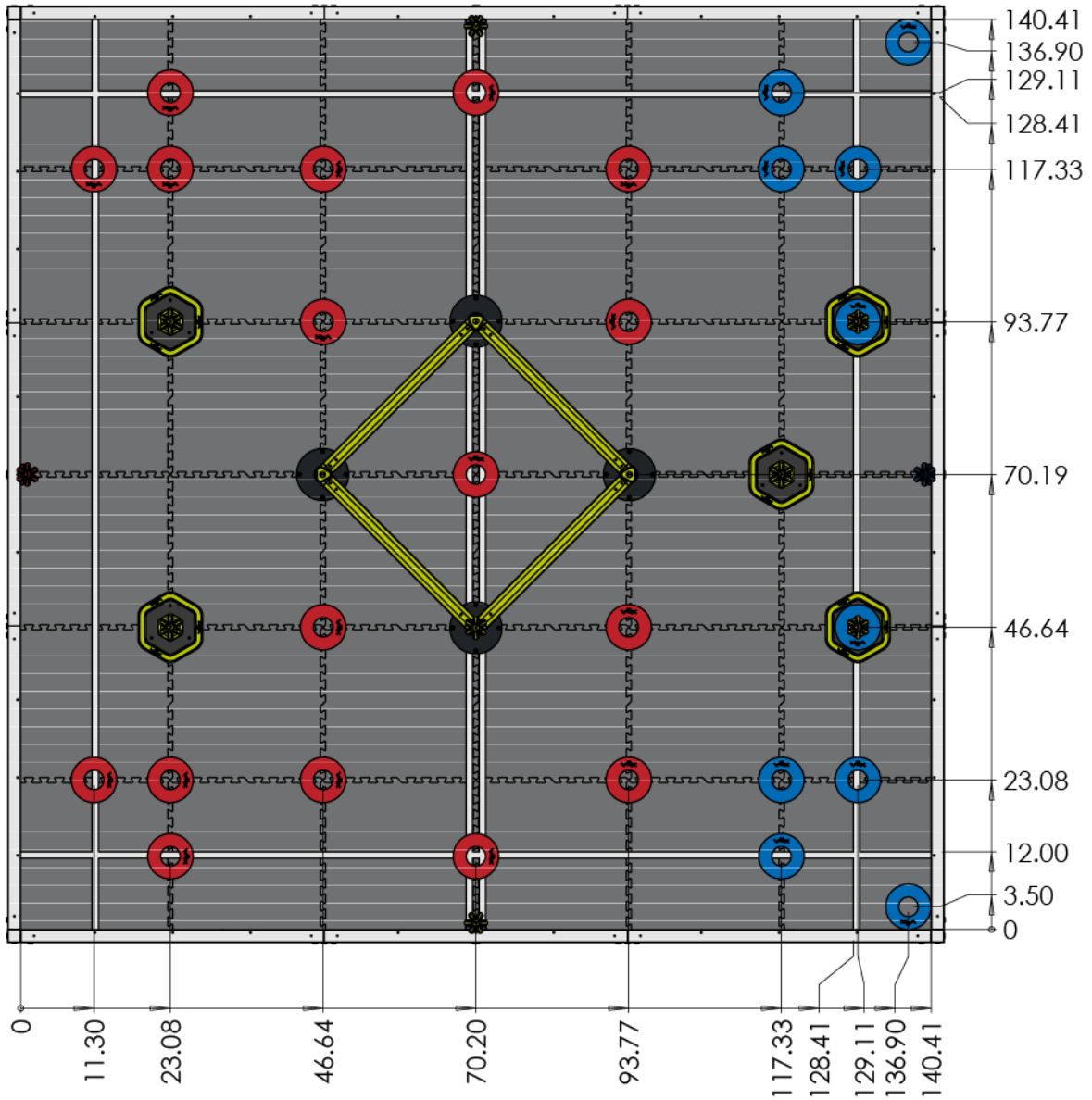
### Reference Object Placement Image, VRC Skills Match



Description	OBJECT PLACEMENT - SKILLS (2)	
Dwg No	276-8868 FIELD SPECIFICATIONS	
Competition	VRC 2024-2025	SHEET 4 OF 15
Release	2/16/2024	<b>ALL DIMENSIONS ARE IN INCHES.</b>

[www.VEXROBOTICS.COM](http://www.VEXROBOTICS.COM)

**FIELD REFERENCE SPECIFICATIONS, VRC SKILLS**

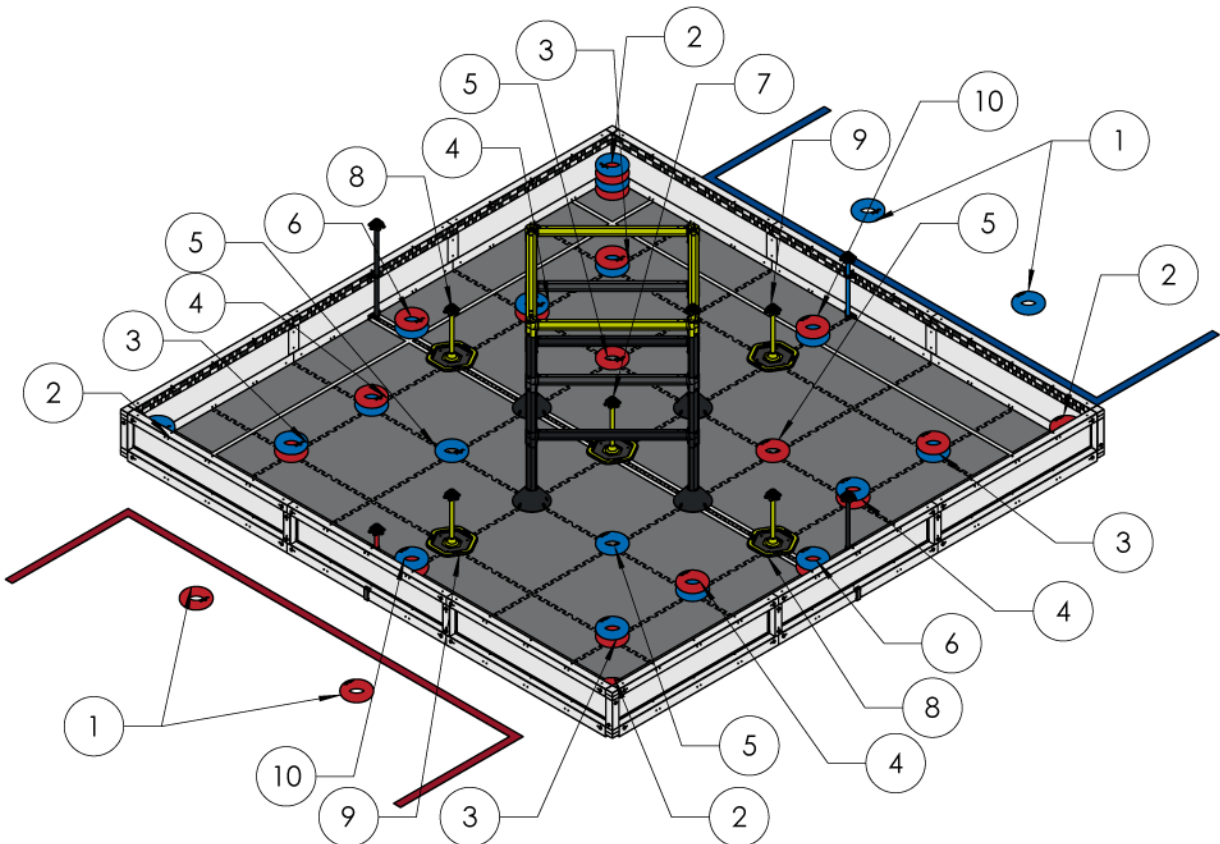


Description	FIELD REFERENCE SPECIFICATIONS - VRC SKILLS	
Dwg No	276-8868 FIELD SPECIFICATIONS	
Competition	VRC 2024-2025	
Release	3/18/2024	<b>ALL DIMENSIONS ARE IN INCHES.</b>

[www.VEXROBOTICS.COM](http://www.VEXROBOTICS.COM)

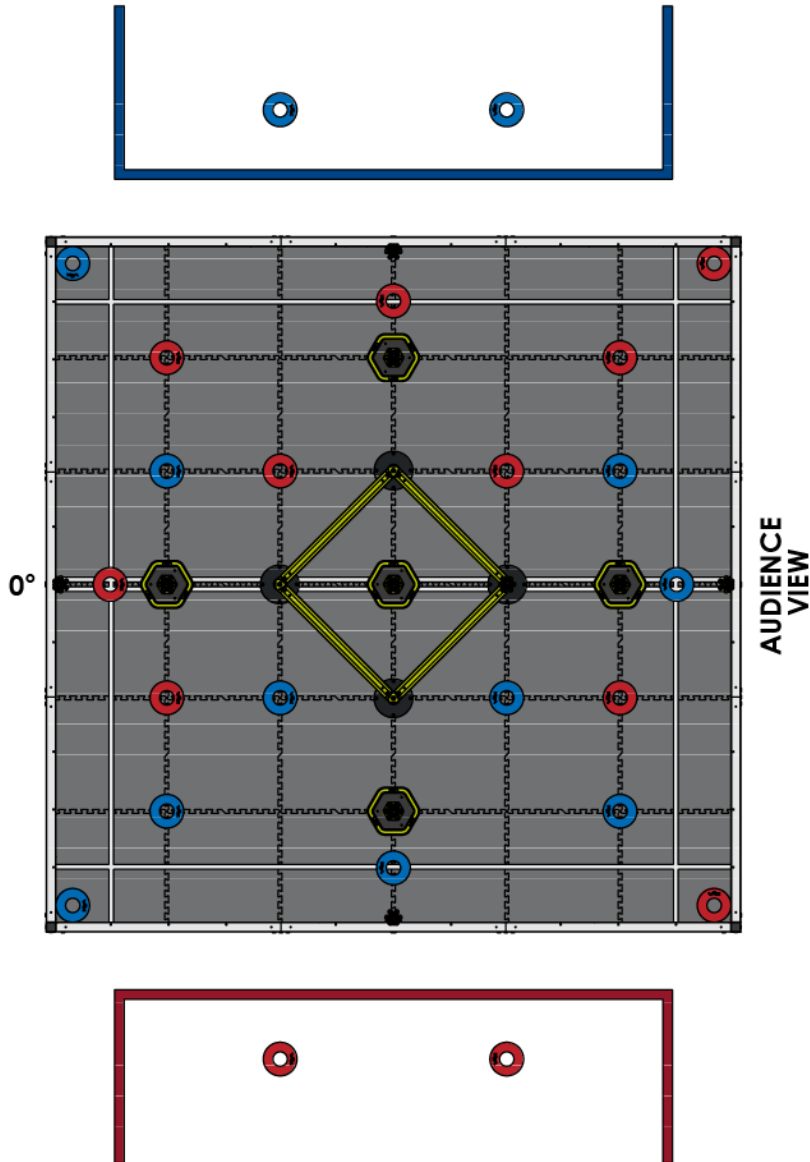
**Scoring Objects are placed as follows before the start of each Head-to-Head VURC Match**

1. (2x) Alliance colored Rings for Preload, (1x) per Team.
2. (4x) Rings in alternating colors placed in each Corner.
3. (4x) Rings, stacked in sets of 2 with alternating colors, placed on the intersection of field tiles closest to the corners. Blue Rings on top on red side and vice versa.
4. (8x) Rings, stacked in sets of 2 with alternating colors, placed 2 tiles from the Alliance walls, 1 tile from the neutral walls. Blue Rings on top on red side and vice versa.
5. (4x) Ring of opposite Alliance color placed 2 tiles from Alliance walls and 2 tiles from neutral walls.
6. (2x) Rings, stacked in sets of 2 with alternating colors, placed on the tape line in front of the Neutral Wall Stakes. Blue Ring on top on Audience side.
7. (1x) Mobile Goal placed in the center of the field, under the Ladder.
8. (2x) Mobile Goals, each placed 1 tile away from the Neutral Wall Stake, on the middle tape line.
9. (2x) Mobile Goals, each placed 1 tile away from the Alliance color wall stake.
10. (2x) Rings, stacked in sets of 2 with alternating colors, placed on the tape line in front of the Alliance color Wall Stakes. Blue Ring on top on red side and vice versa



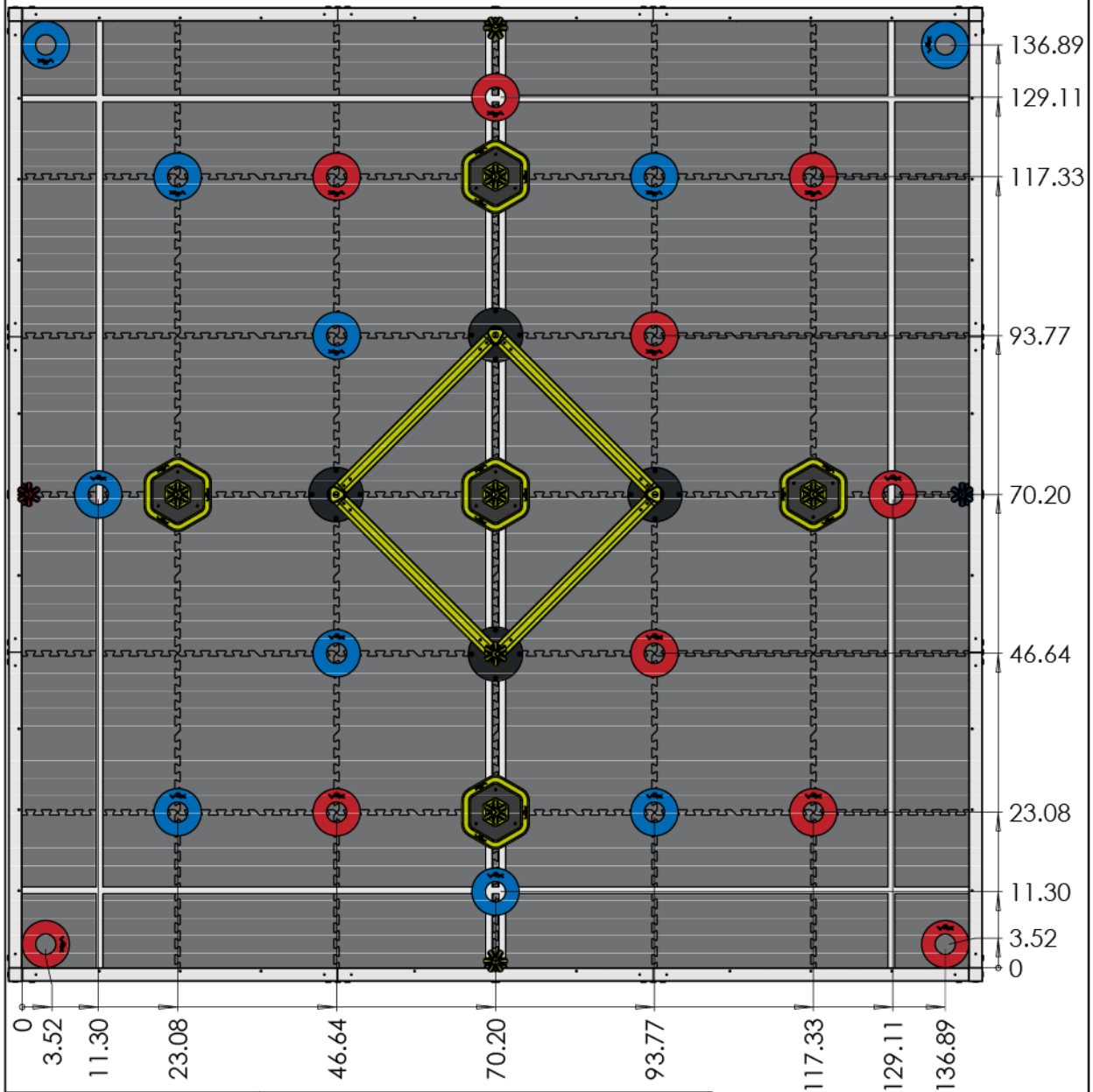
	Description	OBJECT PLACEMENT - VEXU	
	Dwg No	276-8868 FIELD SPECIFICATIONS	
	Competition	VRC 2024-2025	
	Release	4/12/2024	ALL DIMENSIONS ARE IN INCHES.

**Reference Object Placement Image, VURC Head-to-Head Matches**



	Description	REFERENCE OBJECT PLACEMENT - VEXU	
	Dwg No	276-8868 FIELD SPECIFICATIONS	
	Competition	VRC 2024-2025	
	Release	4/12/2024	<b>ALL DIMENSIONS ARE IN INCHES.</b>

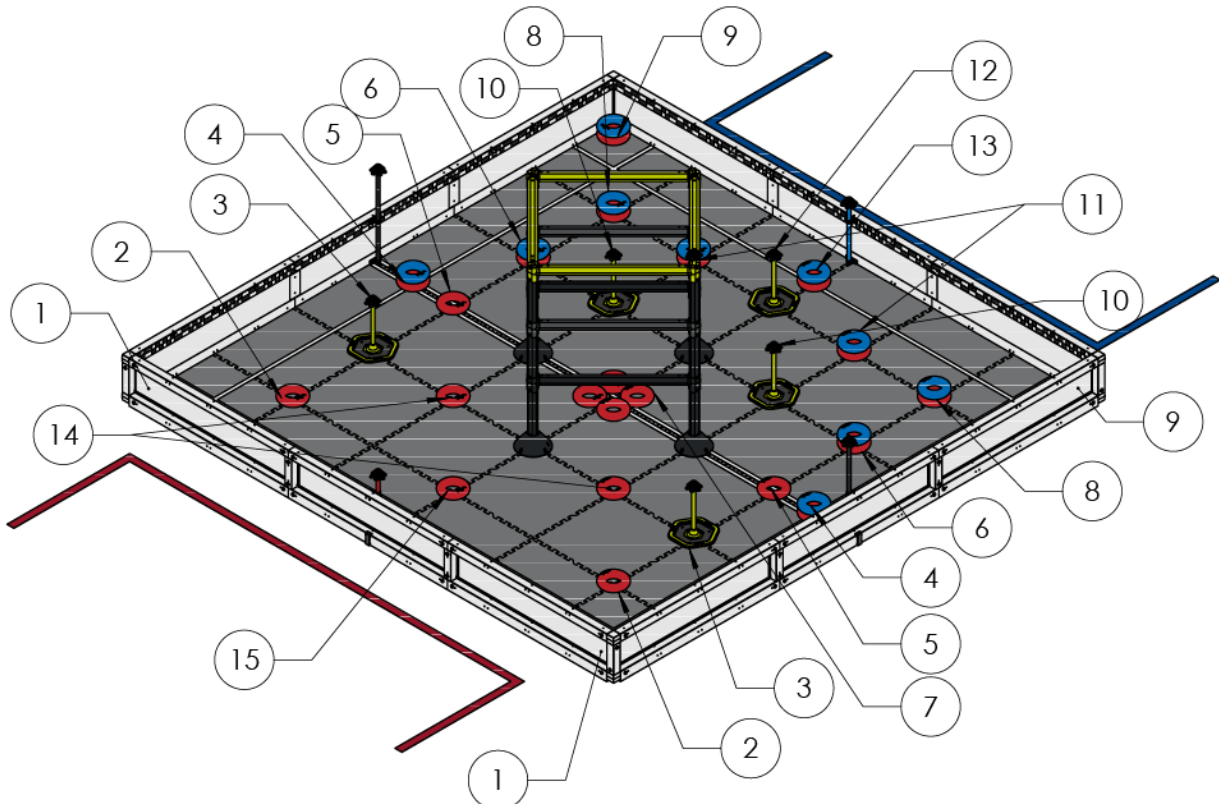
**FIELD REFERENCE SPECIFICATIONS - VURC Head-to-Head**



	Description	FIELD REFERENCE SPECIFICATIONS - VEXU	
	Dwg No	276-8868 FIELD SPECIFICATIONS	
	Competition	VRC 2024-2025	
	Release	4/12/2024	<b>ALL DIMENSIONS ARE IN INCHES.</b>
<a href="http://www.VEXROBOTICS.COM">www.VEXROBOTICS.COM</a>			

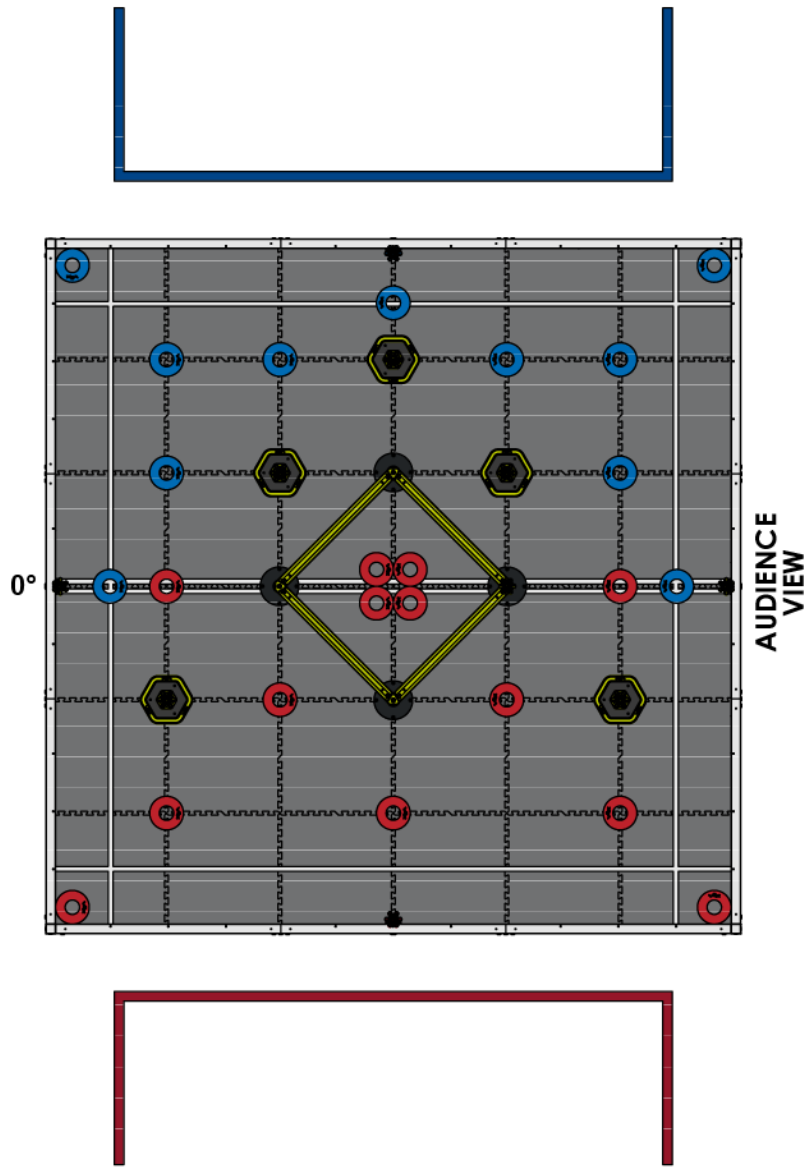
**Scoring Objects are placed as follows in VURC Skills matches:**

1. (2x) Single red Ring placed in the corners on the red Alliance wall.
2. (2x) Single red Ring placed on the intersection of tiles closest to the corners on the red Alliance wall.
3. (2x) Mobile Goals placed 1 tile away from the Neutral walls, 1 tile away from the center line on red Side of the field.
4. (2x) Stack of blue Ring on top of red Ring, on the tape line in front of the Neutral Wall Stakes.
5. (2x) Single red Ring placed 1 tile away from the Neutral Wall Stakes, on the center line.
6. (2x) Stack of blue Ring on top of red Ring, one tile away from neutral walls, one tile away from center line on blue side of the field.
7. (4x) Red Rings, placed in a 2x2 formation, touching each other, directly over the center of the field under the Ladder.
8. (2x) Stack of blue Ring on top of red Ring, placed on the intersection of tiles closest to the corners on the blue Alliance wall.
9. (2x) Stack of blue Ring on top of red Ring, placed in the corners on the blue Alliance wall
10. (2x) Mobile Goals, placed 2 tiles from the Neutral walls, 1 tile from the center line on the blue Alliance side of the field.
11. (2x) Stack of blue Ring on top of red Ring, placed 2 tiles away from the Neutral walls, 1 tile away from the blue Alliance wall.
12. (1x) Mobile goal, placed 1 tile away from the Blue Alliance Wall Stake
13. (1x) Stack of blue Ring on top of red Ring, placed on the tape line in front of the Blue Alliance Wall Stake
14. (2x) Single Red Ring, placed 2 tiles from the Neutral Walls, 2 tiles from the Red Alliance Wall
15. (1x) Single Red Ring, placed 1 tile away from the Red Alliance Wall Stake.



	Description	OBJECT PLACEMENT - VEXU SKILLS	
	Dwg No	276-8868 FIELD SPECIFICATIONS	
	Competition	VRC 2024-2025	
	Release	4/12/2024	ALL DIMENSIONS ARE IN INCHES.

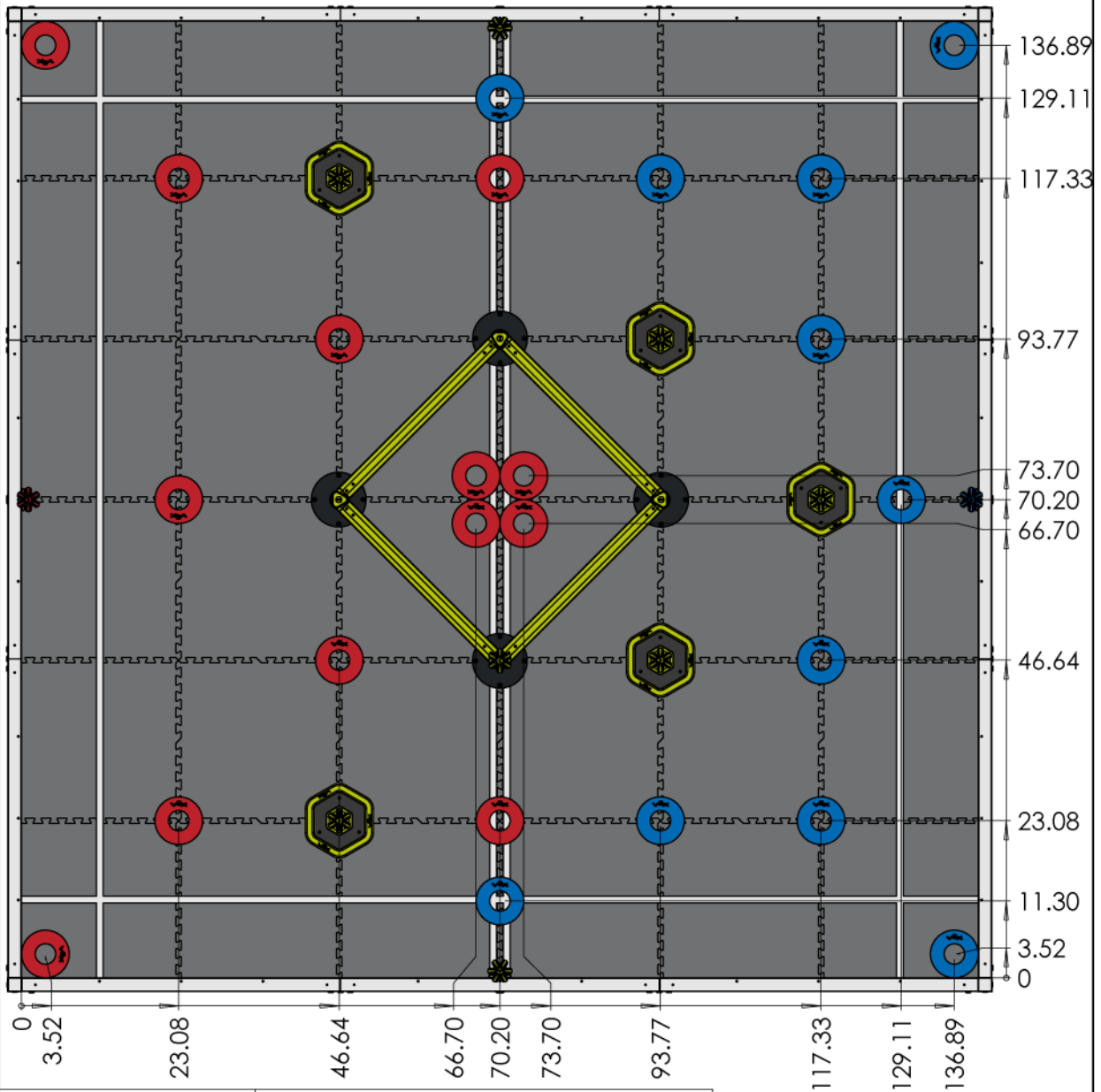
Reference Object Placement Image, VURC Skills



Description	REFERENCE OBJECT PLACEMENT - VEXU SKILLS	
Dwg No	276-8868 FIELD SPECIFICATIONS	
Competition	VRC 2024-2025	
Release	4/12/2024	<b>ALL DIMENSIONS ARE IN INCHES.</b>

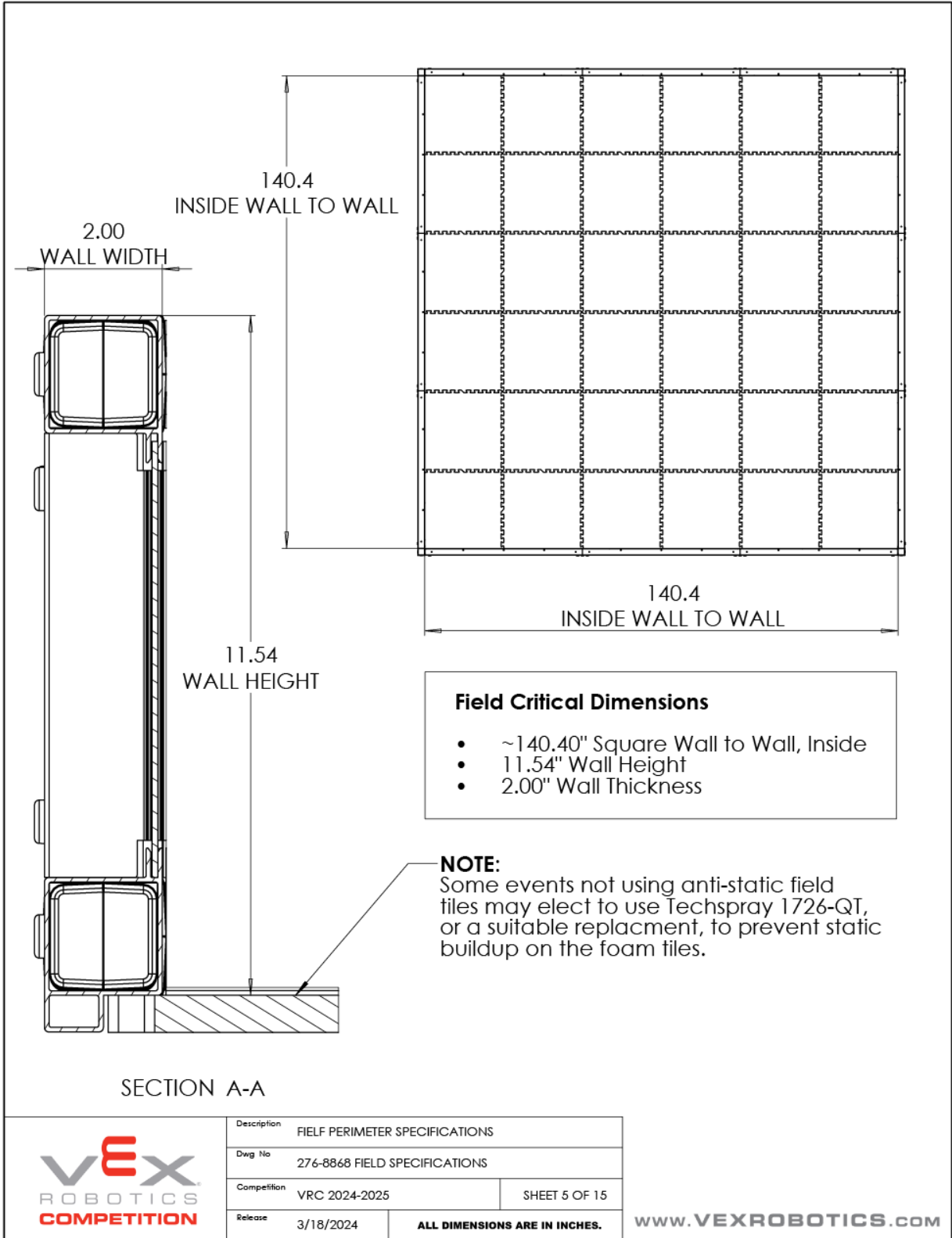
[www.VEXROBOTICS.COM](http://www.VEXROBOTICS.COM)

### FIELD REFERENCE SPECIFICATIONS - VURC Skills

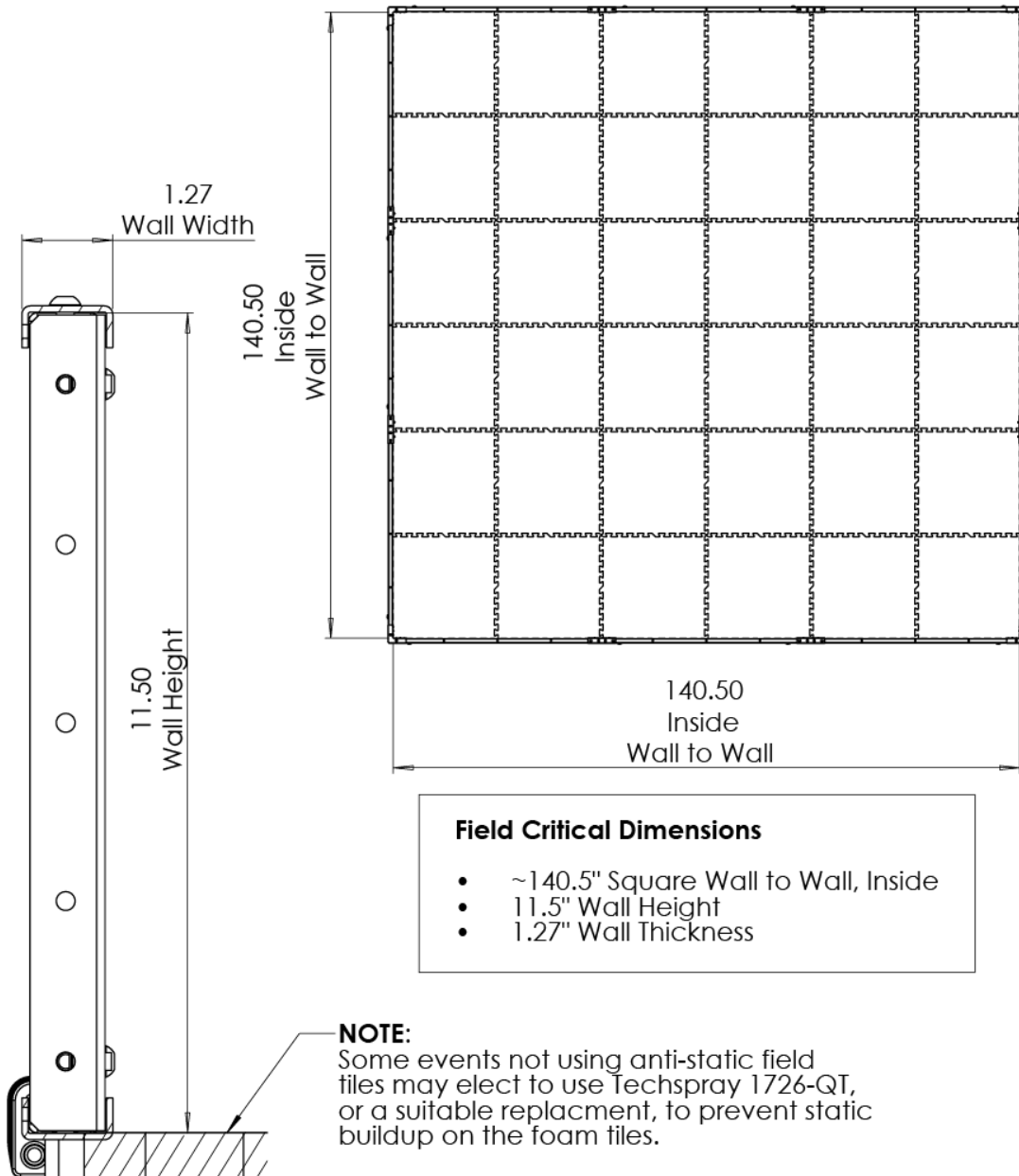


	Description	FIELD REFERENCE SPECIFICATIONS - VEXU SKILLS	
	Dwg No	276-8868 FIELD SPECIFICATIONS	
	Competition	VRC 2024-2025	
	Release	4/12/2024	ALL DIMENSIONS ARE IN INCHES.
<a href="http://www.VEXROBOTICS.COM">www.VEXROBOTICS.COM</a>			





Field Critical Specs (278- 1501):

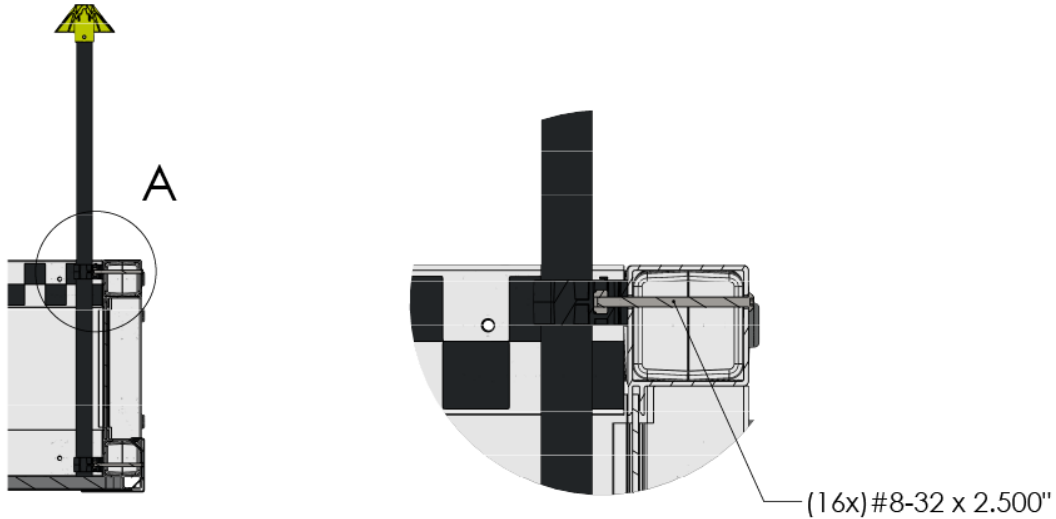


	Description		FIELD PERIMETER SPECIFICATIONS (2)
	Dwg No		276-8868 FIELD SPECIFICATIONS
	Competition	VRC 2024-2025	SHEET 6 OF 15
	Release	3/18/2024	<b>ALL DIMENSIONS ARE IN INCHES.</b>

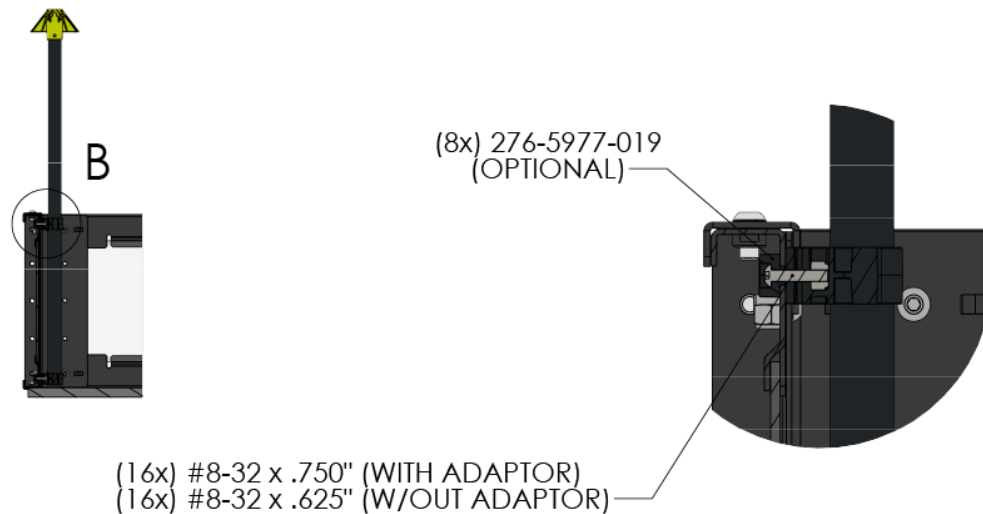
[www.VEXROBOTICS.COM](http://www.VEXROBOTICS.COM)


## FIELD HARDWARE DIFFERENCES

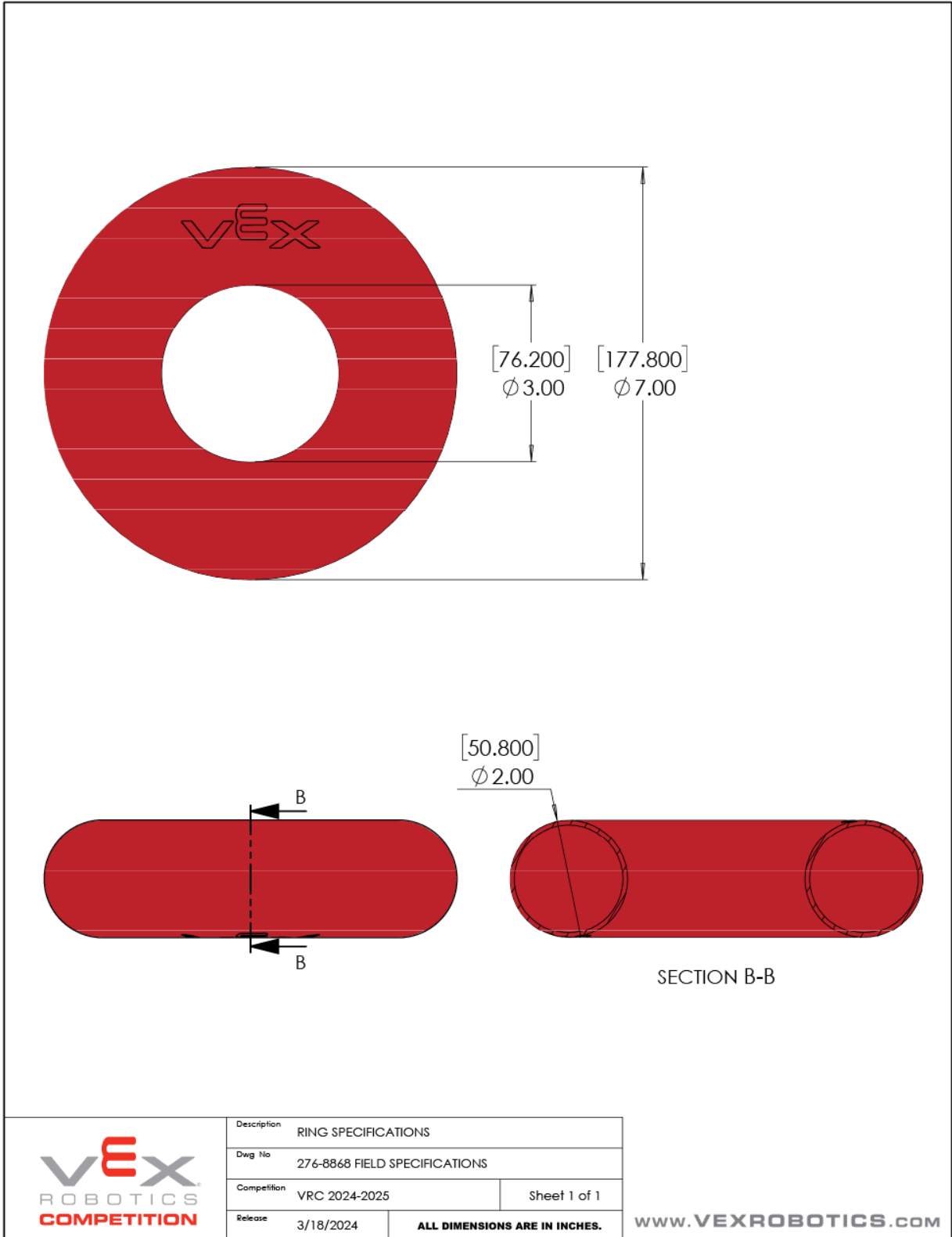
### PORTABLE FIELD HARDWARE (INCLUDED)



### METAL FIELD HARDWARE (NOT INCLUDED)

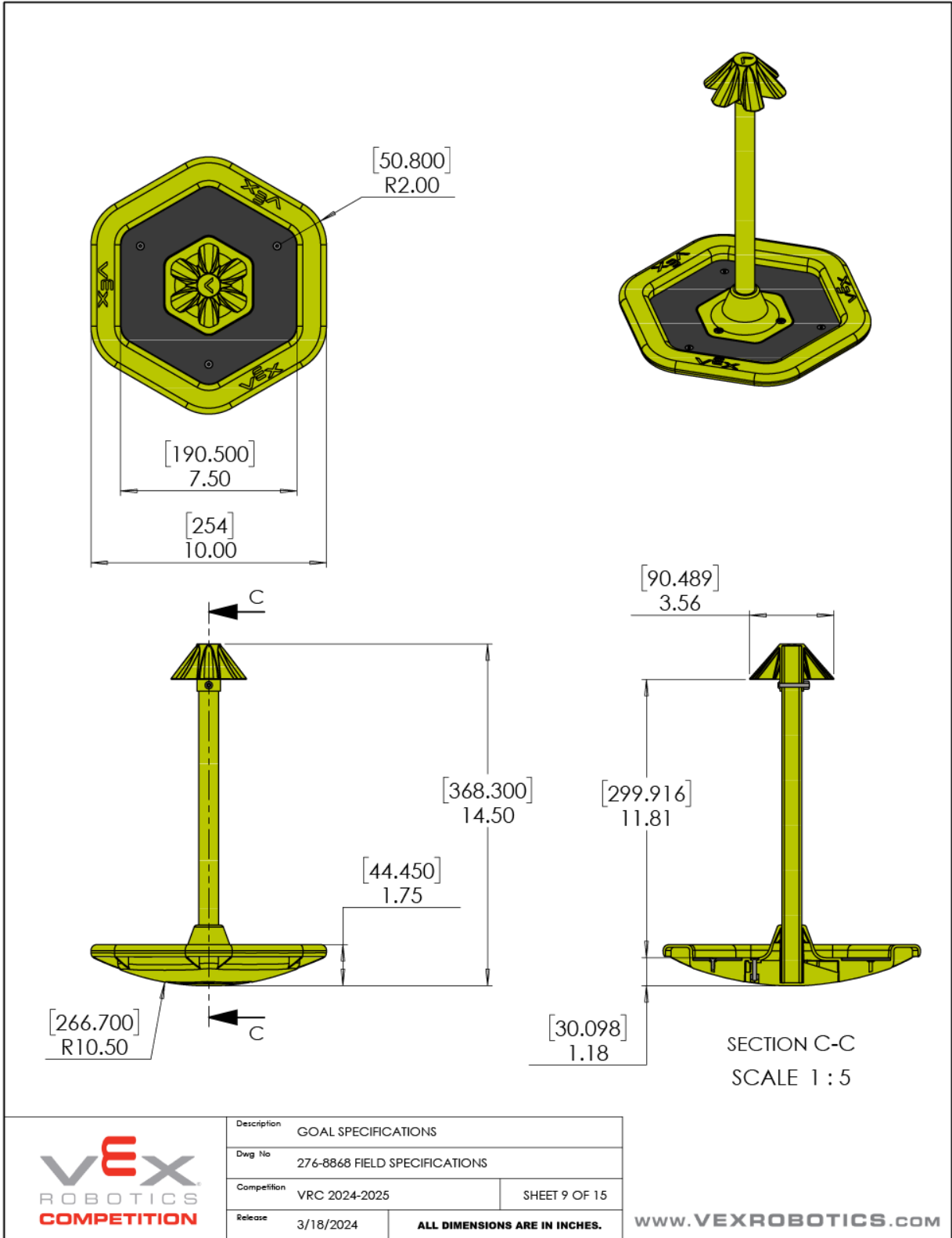


	Description		FIELD HARDWARE DIFFERENCES
	Dwg No		276-8868 FIELD SPECIFICATIONS
	Competition	VRC 2024-2025	SHEET 7 OF 15
	Release	3/18/2024	<b>ALL DIMENSIONS ARE IN INCHES.</b>
			<a href="http://www.VEXROBOTICS.COM">www.VEXROBOTICS.COM</a>

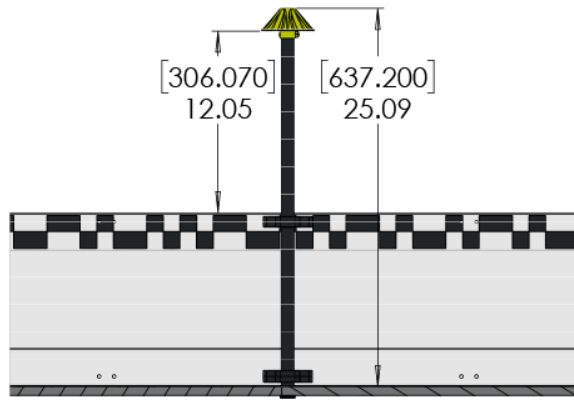


	Description RING SPECIFICATIONS	
	Dwg No 276-8868 FIELD SPECIFICATIONS	
	Competition VRC 2024-2025	Sheet 1 of 1
	Release 3/18/2024	ALL DIMENSIONS ARE IN INCHES.

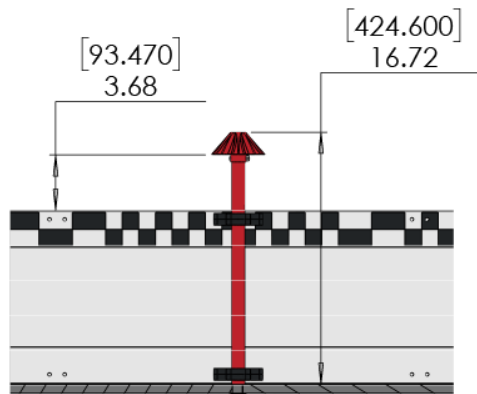
WWW.VEXROBOTICS.COM




NEUTRAL STATIONARY GOALS:

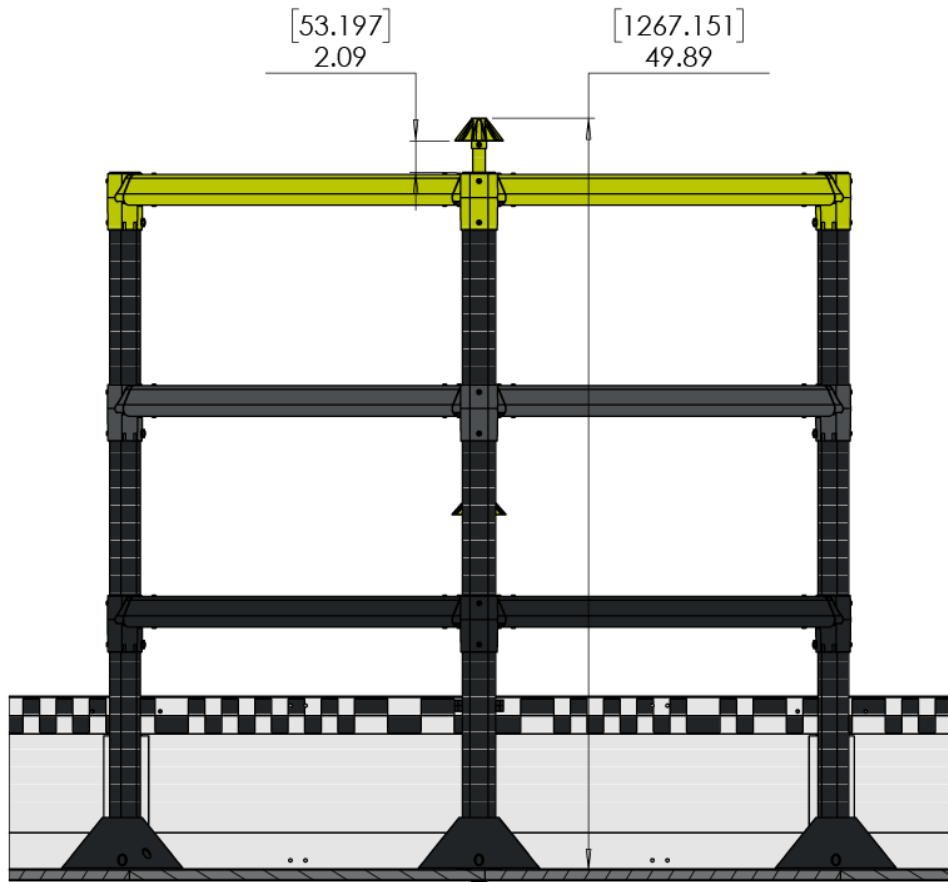


ALLIANCE SPECIFIC STATIONARY GOALS:

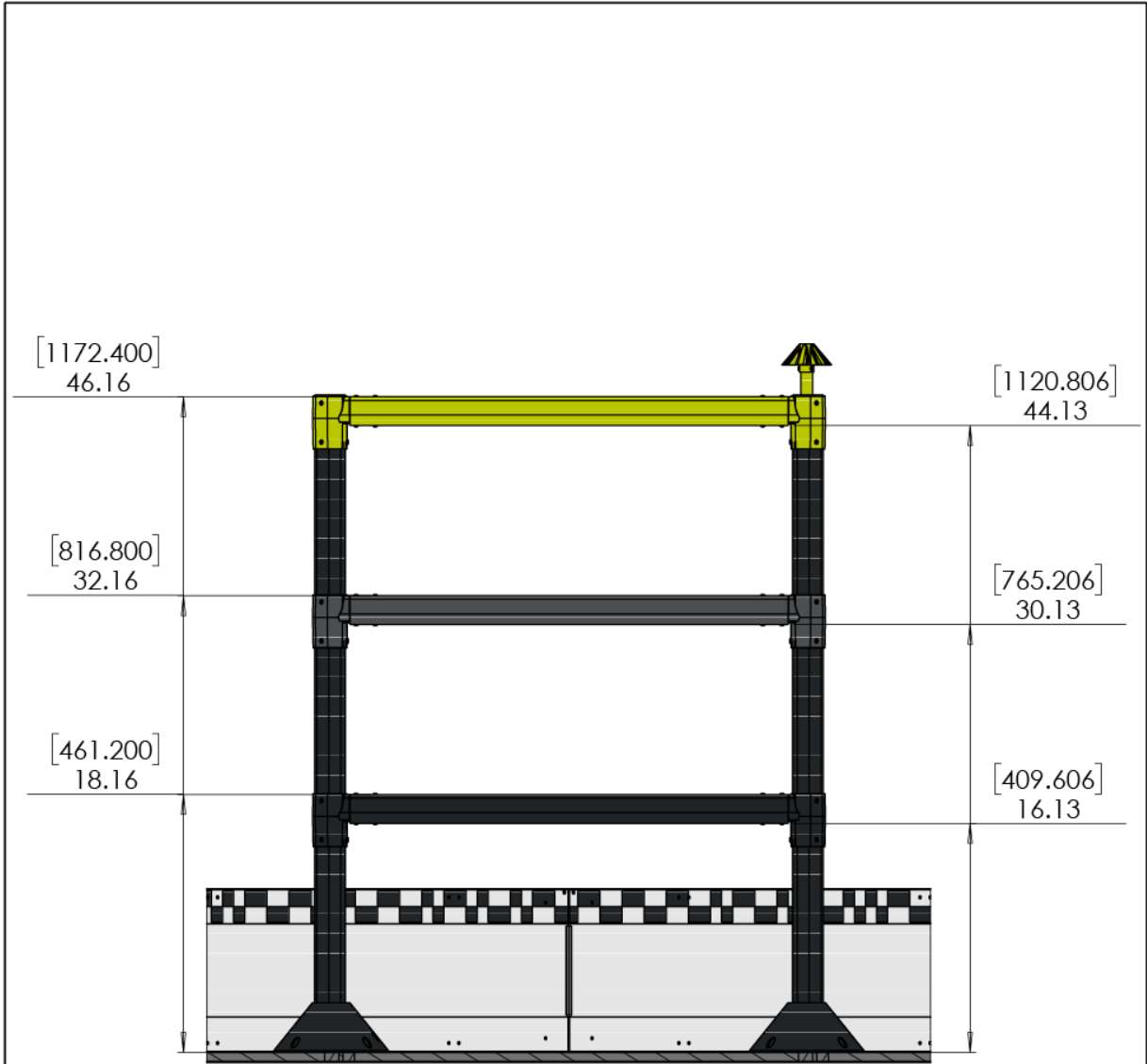


	Description GOAL SPECIFICATIONS (2)	
	Dwg No 276-8868 FIELD SPECIFICATIONS	
	Competition VRC 2024-2025	SHEET 10 OF 15
	Release 3/18/2024	ALL DIMENSIONS ARE IN INCHES.

[www.VEXROBOTICS.COM](http://www.VEXROBOTICS.COM)



	Description GOAL SPECIFICATIONS (3)	
	Dwg No 276-8868 FIELD SPECIFICATIONS	
	Competition VRC 2024-2025	SHEET 11 OF 15
	Release 3/18/2024	ALL DIMENSIONS ARE IN INCHES.
		WWW.VEXROBOTICS.COM



	Description LADDER SPECIFICATIONS	
	Dwg No 276-8868 FIELD SPECIFICATIONS	
	Competition VRC 2024-2025	SHEET 12 OF 15
	Release 3/18/2024	ALL DIMENSIONS ARE IN INCHES.

[www.VEXROBOTICS.COM](http://www.VEXROBOTICS.COM)



